

**DAQSTATION DX100/DX200
Communication Interface**

IM 04L02A01-17E



Forward

Thank you for purchasing the YOKOGAWA DAQSTATION DX100/DX200. This Communication Interface User's Manual contains information about the Ethernet/serial interface communication functions. To ensure correct use, please read this manual thoroughly before operation.

Keep this manual in a safe place for quick reference in the event a question arises. The following five manuals, including this one, are provided as manuals for the DX100/DX200.

Manual Name	Manual No.	Description
DX100 User's Manual	IM 04L01A01-01E	Explains all functions and procedures of the DX100 excluding the communication functions.
DX200 User's Manual	IM 04L02A01-01E	Explains all functions and procedures of the DX200 excluding the communication functions.
DX100/DX200 Communication Interface	IM 04L02A01-17E	This manual. Explains the communication functions of the Ethernet/serial interface.
Fieldbus Communication Interface	IM 04L02A01-18E	Explains the communication functions of the FOUNDATION Fieldbus interface. For models with /CF1 only.
DAQSTANDARD	IM 04L02A01-61E	Describes the functions and operating procedures of DAQSTANDARD.

Notes

- This manual describes the communication functions of the DX100/DX200 with the style number "S4."
- The contents of this manual are subject to change without prior notice as a result of continuing improvements to the instrument's performance and functions. The figures given in this manual may differ from the actual screen.
- Every effort has been made in the preparation of this manual to ensure the accuracy of its contents. However, should you have any questions or find any errors, please contact your nearest YOKOGAWA dealer as listed on the back cover of this manual.
- Copying or reproducing all or any part of the contents of this manual without YOKOGAWA's permission is strictly prohibited.
- The TCP/IP software used in this product and the documentation for that TCP/IP software are based in part on BSD Networking Software, Release 1 licensed from The Regents of the University of California.

Trademarks

- Microsoft, MS-DOS, Windows, and Windows NT are either registered trademarks or trademarks of Microsoft Corporation in the United States and/or other countries.
- Modbus is a registered trademark of AEG Schneider Automation Incorporated.
- "FOUNDATION" of FOUNDATION Fieldbus is a trademark of Fieldbus Foundation.
- Adobe and Acrobat are trademarks of Adobe Systems incorporated.
- Other company and product names are trademarks or registered trademarks of their respective holders.

Revisions

- First edition: September 1999
- Second edition: October 1999
- Third edition: February 2000
- Fourth edition: May 2000
- Fifth edition: February 2001
- Sixth edition: February 2002

How to Use this Manual

Structure of the Manual

The structure of this User's Manual is as follows.

Chapter 1 Overview of the Communication Functions

Describes the relationship between the communication functions and the interface and provides an outline of the communication functions.

Chapter 2 Using the Ethernet Interface

Describes the specifications and setup procedures of the Ethernet interface. Describes the FTP client function, Web server function, and e-mail transmission function. Also describes how to display the log screen.

Chapter 3 Using the Serial Interface (Option)

Describes the functions, specifications, and setup procedures of the serial interface (option). Two types of serial interfaces, RS-232 and RS-422-A/485 are available.

Chapter 4 Using the Modbus Protocol

Describes the specifications and setup procedures of the Modbus protocol and the status indication screen of the Modbus master.

Chapter 5 Commands

Describes each command that can be used.

Chapter 6 Response

Describes the data format of the panel setup information and measured/computed data that are output from this instrument.

Chapter 7 Status Report

Describes the status information.

Appendix

Provides an ASCII character code table, the flow of operation when outputting data from DX, a list of error messages, and the login process.

Index

Provides an index.

Conventions Used in this Manual

Unit

- k Denotes 1000. Example: 5 kg, 100 kHz
- K Denotes 1024. Example: 720 KB (Storage capacity of floppy disks)

Symbols

The following symbols are used in this manual.



Affixed to the instrument. Indicates danger to personnel or instrument and the operator must refer to the User's Manual. The symbol is used in the User's Manual to indicate the reference.

WARNING

Describes precautions that should be observed to prevent injury or death to the user.

CAUTION

Describes precautions that should be observed to prevent minor or moderate injury, or damage to the instrument.

Note

Provides important information for the proper operation of the instrument.

Displayed characters

Alphanumeric characters enclosed with [] refer to characters or setting values that are displayed on the screen.

Symbols used on pages describing operating procedures

On pages that describe the operating procedures in Chapter 2 through 4, the following symbols are used to distinguish the procedures from their explanations.

Explanation

This section describes the setting parameters and the limitations regarding the procedures.

Procedure

Follow the steps indicated with numbers. The procedures are given with the premise that the user is carrying out the steps for the time. Depending on the operation, not all steps need to be taken.

Names and Uses of Parts

Front Panel

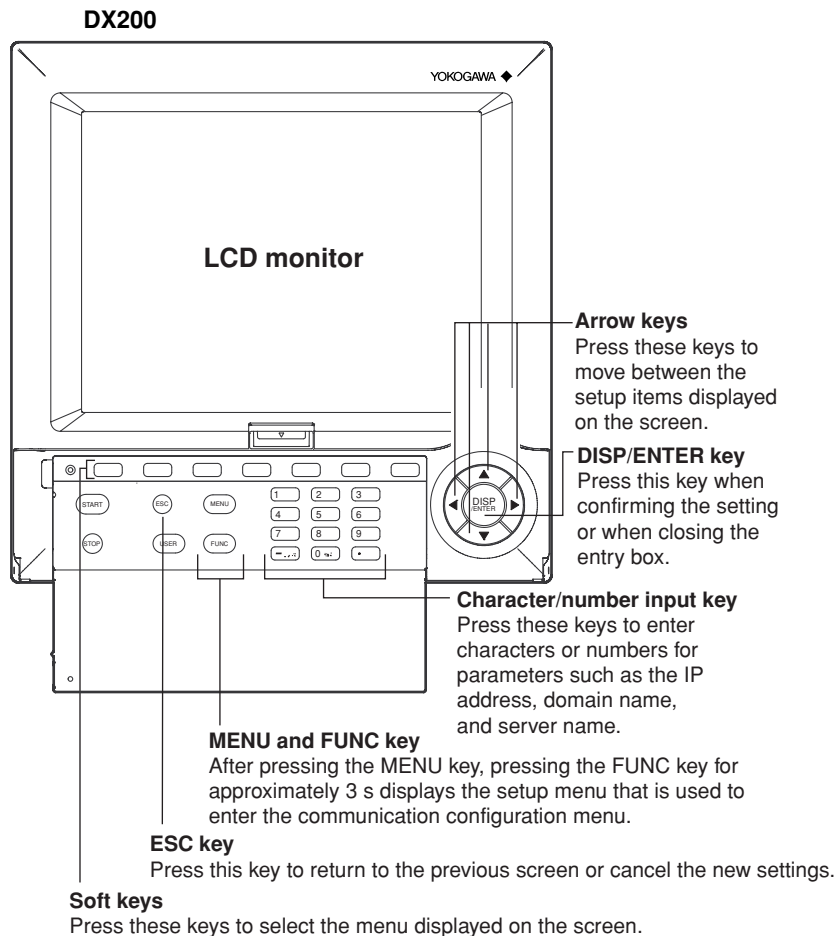
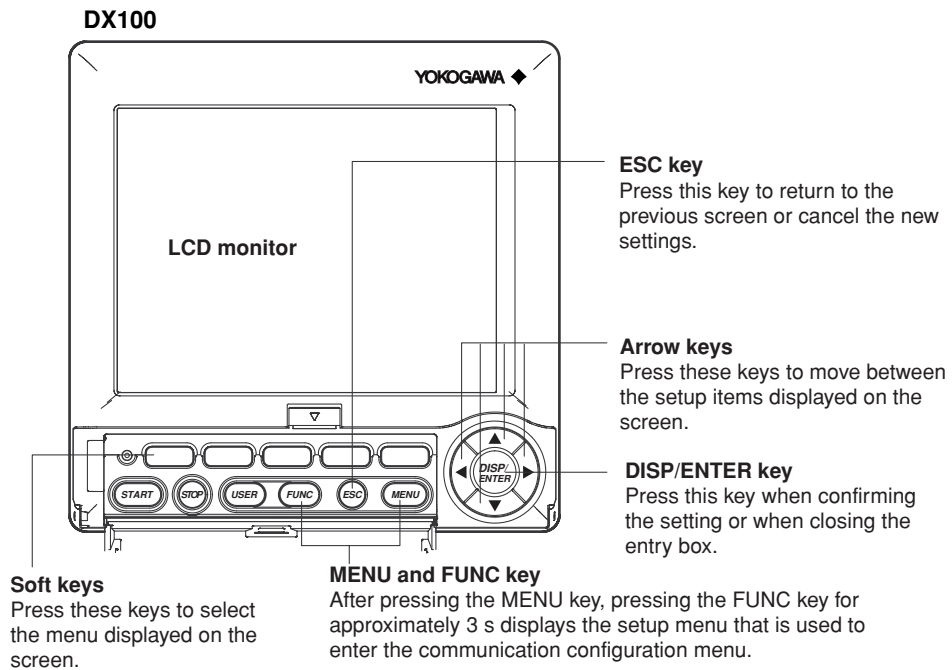

Rear Panel

DX100

Ethernet interface connector

A connector used for Ethernet communications. Comes standard with the instrument.

RS-232 interface connector

A serial communication connector provided on models with the optional code /C2.

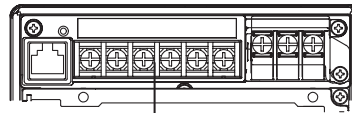
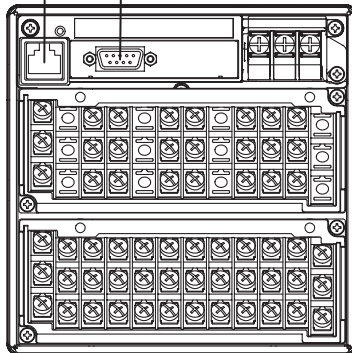

RS-422-A/485 interface terminal

Serial communication terminals provided on models with the optional code /C3.

DX200

Ethernet interface connector

A connector used for Ethernet communications. Comes standard with the instrument.

RS-232 interface connector

A serial communication connector provided on models with the optional code /C2.

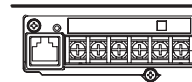
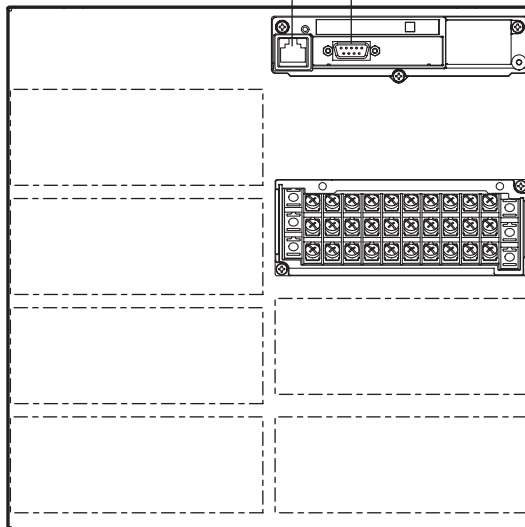

RS-422-A/485 interface terminal

Serial communication terminals provided on models with the optional code /C3.

Flow of Operation using the Operation Keys

This section will describe the basic flow of operation when changing the settings of the recorder using the front panel keys.

Settings related to communications are configured in the basic setting mode. The procedure used to enter the basic setting mode is described in the procedure for each item. Basic setting mode cannot be entered while data acquisition is in progress or while computation using the computation function (/M1 option) is in progress.

1. Press the arrow keys to move the cursor onto the desired parameter.



2. For parameters whose selections are shown at the bottom of the screen, press the soft key under the desired selection. For parameters that need characters to be entered in the entry box, press the [Input] soft key to display the entry box, enter the characters, and press the DISP/ENTER key.

Parameter selections
(Selection example for [DNS On/Off]
Press either the [On] or [Off] soft key.)

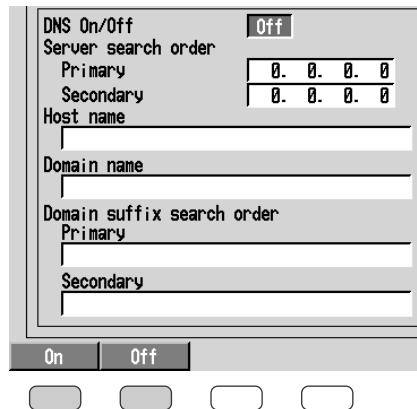

Parameter entry box
(Example of the entry box for the IP address)

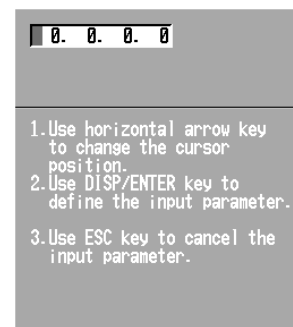

- The boxes containing parameters that have not been changed are displayed in white.
- The boxes containing parameters that have been changed are displayed in yellow.

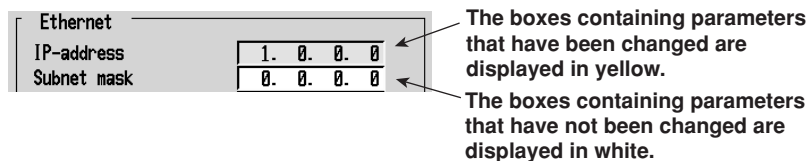

3. Set other parameters as well according to steps 1 and 2.
4. The operation is different when you are confirming or canceling the new changes (parameter boxes in yellow). See below.
 - When confirming the new changes
Press the DISP/ENTER key. The new changes are confirmed and the yellow parameter boxes change to white. The cursor returns to the parameter at the upper left portion of the screen (the first parameter on the screen). However, if the new change is not valid, then the parameter box turns red.

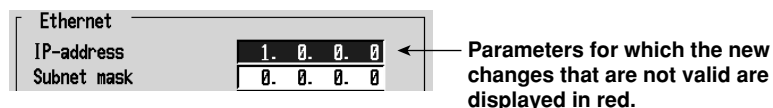

- When canceling the new changes
Press the ESC key. A window appears for you to confirm the cancellation. Selecting “YES” and pressing the DISP/ENTER key cancels the new settings and the screen returns to the previous screen.
Selecting “No” and pressing the DISP/ENTER key does not cancel the new settings and the screen returns to the original screen.

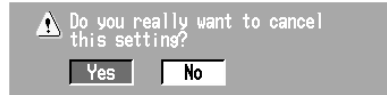

5. To activate the new settings in the basic setting mode, the settings must be stored. Pressing the [End] soft key in the basic setting menu* displays a dialog box that asks you whether or not the new settings are to be stored. To store the settings, select [Yes]. To not store the settings, select [No]. To return to the basic setting menu, select [Cancel] by pressing the arrow key, and press the [DISP/ENTER] key.

* The basic setting menu is the menu that is displayed when the ESC key is pressed several times after the basic setting parameters are changed.

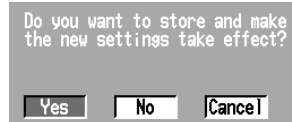

Contents

Forward	i
How to Use this Manual	ii
Names and Uses of Parts	iv

Chapter 1 Overview of the Communication Functions

1.1 The Relationship between the Communication Functions and the Ethernet/Serial Interface	1-1
1.2 Explanation of the Functions	1-2

Chapter 2 Using the Ethernet Interface

2.1 Ethernet Interface Specifications	2-1
2.2 Connecting the Ethernet Interface	2-2
2.3 Configuring the Ethernet Interface	2-3
2.4 Checking the Connection Status of the Ethernet Interface	2-9
2.5 Setting the FTP Client (Automatic Transfer of Display/Event/Report Data Files)	2-10
2.6 Performing the FTP Test	2-16
2.7 Setting the Login/Timeout for Ethernet Communications	2-17
2.8 Displaying the Log Screen of the Error, Communication, and FTP	2-22
2.9 Setting the Web Server Function	2-26
2.10 Using the Monitor Page and Operator Page	2-31
2.11 Setting the E-Mail Transmission Function	2-38
2.12 Performing an E-Mail Transmission Test	2-47
2.13 Starting/Stopping E-Mail Transmissions	2-48

Chapter 3 Using the Serial Interface (Option)

3.1 Serial Interface (Option) Specifications	3-1
3.2 RS-232 Interface Connector Pin Arrangement and Signal Names, the Connection Procedure, and Handshaking	3-2
 3.3 RS-422A/485 Interface Pin Arrangement and Signal Names and the Connection Procedure	3-5
3.4 The Bit Structure of One Character and the Operation of the Receive Buffer	3-9
3.5 Configuring the Serial Interface	3-10

Chapter 4 Using the Modbus Protocol

4.1 Modbus Protocol Specifications	4-1
4.2 Register Assignments (Modbus Slave)	4-2
4.3 Modbus Error Response (Modbus Slave)	4-3
4.4 Setting the Configuration that is Used When the Modbus Protocol is Used	4-4
4.5 Setting the Modbus Master Function	4-7
4.6 Checking the Operating Status of the Modbus Master Function	4-13

Chapter 5 Commands

5.1	Command Syntax	5-1
5.2	A List of Commands	5-3
5.3	Input Range Parameter	5-7
5.4	Setting Commands (Setting)	5-9
5.5	Setting Commands (Control)	5-17
5.6	Basic Setting Commands	5-20
5.7	Output Commands (Control)	5-29
5.8	Output Commands (Setup, measured, and computed data output)	5-29
5.9	Output Commands (RS-422A/485 Dedicated Commands)	5-32
5.10	Maintenance/Test Commands (Available when using the maintenance/test server function via Ethernet communications)	5-33
5.11	Instrument Information Output Commands (Available when using the instrument information server function via Ethernet communications)	5-34

Chapter 6 Response

6.1	Response Syntax	6-1
6.2	Output Format of ASCII Data	6-6
6.3	Output Format of BINARY Data	6-20
6.4	Output Format of Instrument Information	6-25

Chapter 7 Status Report

7.1	Status Information and Filter	7-1
7.2	The Bit Structure of the Status Information	7-2

Appendix

Appendix 1	ASCII Character Codes	App-1
Appendix 2	Output Flow of Internal Memory Data	App-2
Appendix 3	Output Flow of the File or the File List in the External Storage Medium	App-4
Appendix 4	Output Flow of FIFO Data	App-6
Appendix 5	Data Dropout (Modbus Master)	App-8
Appendix 6	A List of Error Messages	App-9
Appendix 7	Login Process	App-16

Index

1

2

3

4

5

6

7

App

Index

1.1 The Relationship between the Communication Functions and the Ethernet/Serial Interface

The Ethernet interface comes as standard equipment with the instrument. The serial interface (RS-232, RS-422A/485) is available as an option.

In order to use the various communication functions of the DX, the Ethernet or serial communications must be configured beforehand.

The following figure illustrates the relationship between the communication functions of the DX and the Ethernet/serial interface. To use the communication functions of the DX over the Ethernet/serial interface, protocols* that exist between the function and the interface must be followed.

* A protocol is a set of rules that govern the communication between two computers over a line or network.

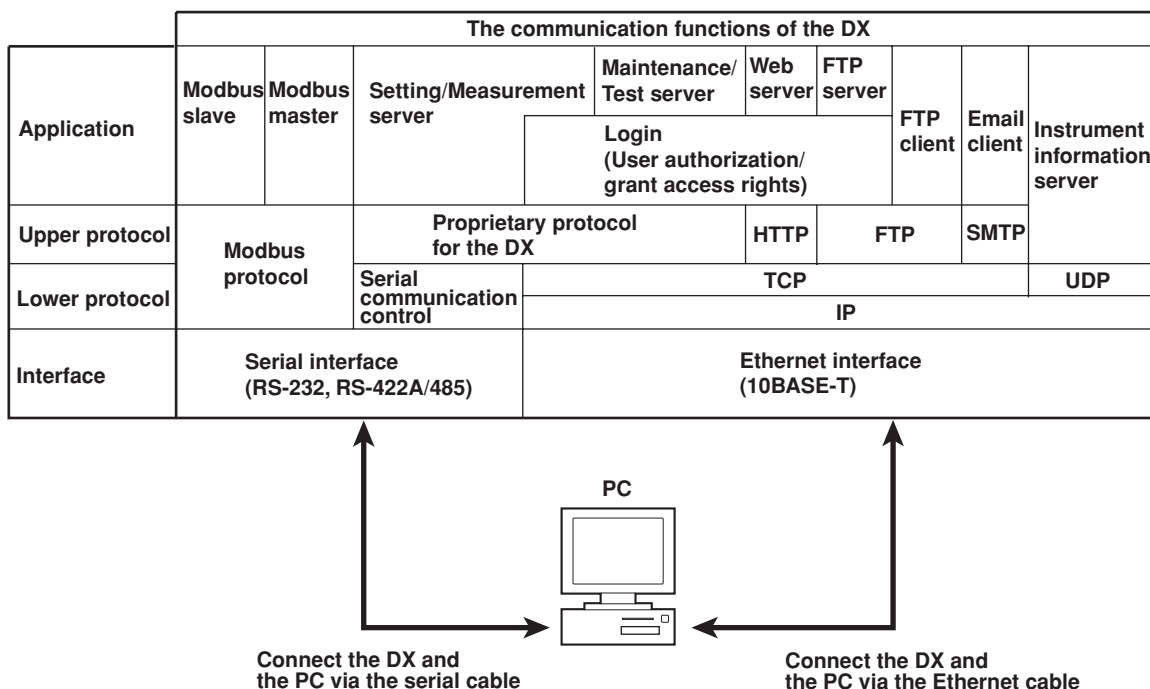

- FTP (File Transfer Protocol)
- TCP (Transmission Control Protocol)
- UDP (User Datagram Protocol)
- IP (Internet Protocol)
- HTTP (Hyper Text Transfer Protocol)
- SMTP (Simple Mail Transfer Protocol)

When you use the serial interface, select one of the following protocols.

- Proprietary protocol for the DX
- Modbus slave protocol
- Modbus master protocol

1.2 Explanation of the Functions

Describes an outline of the communication functions of the DX.

Modbus slave

- By using the Modbus protocol, measured/computed data written to the DX's input register can be read by the PC and communication input data can be written/read from the DX's hold register.
- For the Modbus function codes that are supported by the DX, see section 4.1.
- This function can be used only when communicating via the serial interface (option).
- For the settings required to use the functions, see section 4.4.

Modbus master device

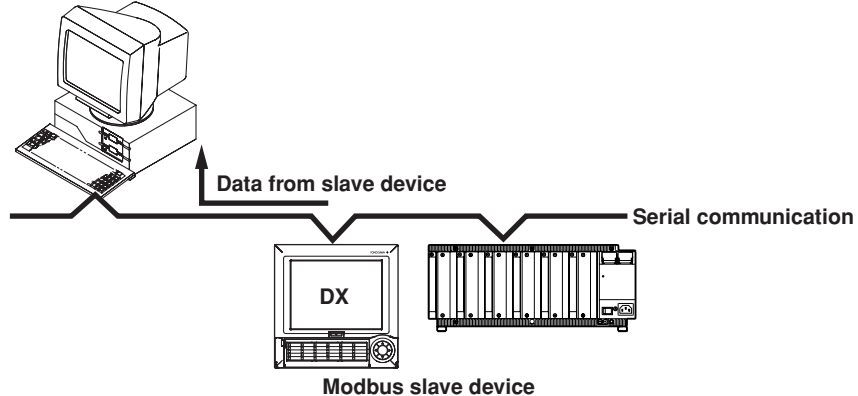

Modbus master

- Loads the measured data of other instruments using the Modbus protocol. The loaded data can be handled as communication input data of the computation function (/M1 option) on the computation channel.
- Function for writing data to other instruments is not supported.
- For details on the Modbus function codes that are supported, see section 4.1.
- This function can be used only when communicating via the serial interface (option).
- For the settings required in using this function, see section 4.4 and 4.5.

Modbus master device

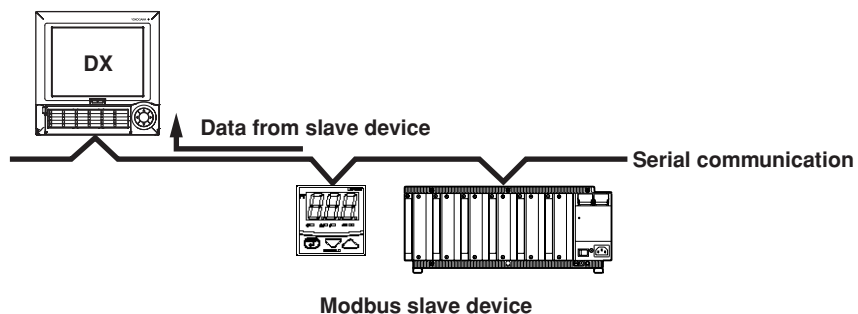

Setting/Measurement server

- This function can be used to set almost all of the settings that can be configured using the front panel keys. However, the power switch cannot be turned ON/OFF. The user name/password for communications, user name/password for key login, and the destination of the FTP client function cannot be configured.
- The following types of data can be output.
 - Measured/computed data.
 - Data in the internal memory or files in the external storage medium.
 - Setup information and the status byte.
 - A log of operation errors and communications

The measured/computed data can be output in binary or ASCII format to a PC. For other types of data, ASCII format is used. For the data output format, see chapter 6. The communication commands that can be used through this function are setting commands (see sections 5.4 and 5.5), basic setting commands (see sections 5.6), and output commands (see sections 5.7 to 5.9).
- This function can be used when communicating via the Ethernet or the serial (optional) interface.
- For the configuration when using Ethernet communications, see sections 2.3 and 2.7. For the configuration when using serial communications, see section 3.5.

Maintenance/Test server

- Connection information, network information, and other information regarding Ethernet communications can be output.
- The communication commands that can be used through this function are maintenance/test commands (see section 5.10).
- This function can be used only when communicating via the Ethernet interface.
- For the configuration required to use this function, see sections 2.3 and 2.7.

FTP server

- You can use a PC to access the DX via FTP. You can perform operations such as retrieving directory and file lists from the external storage medium of the DX and transferring and deleting files.
- This function can be used only when communicating via the Ethernet interface.
- For the configuration required to use this function, see sections 2.3 and 2.7.

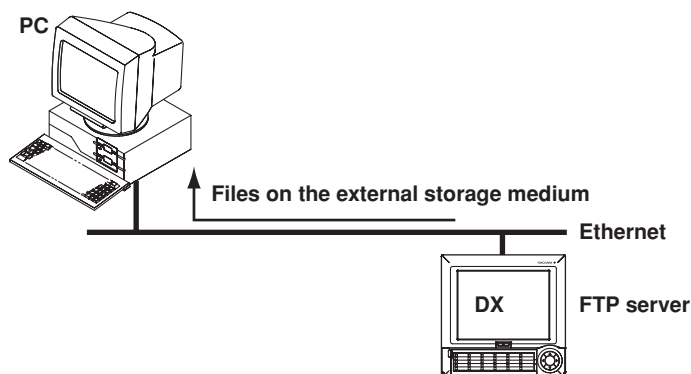

FTP client

Automatic file transfer

- The display data file, event data file, and report data file, that are created in the internal memory of the DX, can be automatically transferred to a remote FTP server. The result of the transfer is recorded in the FTP log. The FTP log can be displayed on the DX's screen (see paragraph "Displaying error/communications/FTP logs" described later) or output to a PC using commands.

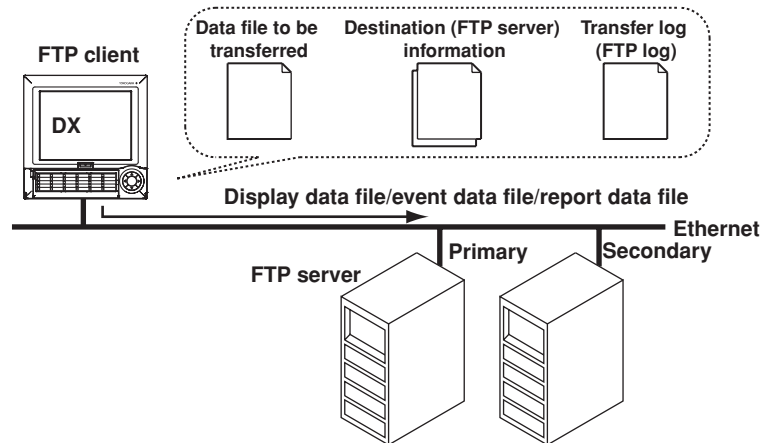

Up to two file transfer destinations (FTP servers) can be specified (primary and secondary). If the primary server is down, the file is transferred to the secondary server.

- This function can be used only when communicating via the Ethernet interface.
- For the configuration required to use this function, see sections 2.3 and 2.5.

FTP test

- The file transfer can be checked by transferring a test file from the DX to a remote FTP server.
- The result of the FTP test can be confirmed on the FTP log screen.
- This function can be used only when communicating via the Ethernet interface.
- For the configuration required to use this function, see section 2.6.

Instrument information server

- The serial number and model of the DX connected to Ethernet can be output.
- The communication commands that can be used through this function are instrument information output commands (see section 5.11).
- This function can be used only when communicating via the Ethernet interface.
- For the configuration required to use this function, see section 2.3.

Login

- This function can be used only when communicating via the Ethernet interface and when using the setting/measurement server, maintenance/test server, and the FTP server functions.
- For the configuration required to use this function, see sections 2.3 and 2.7.
- For a description of the login process of the setting/measurement server and maintenance/test server, see appendix 7.

User authorization

This function allows only registered users to access the DX in order to prevent invalid access from the network.

- Up to seven names can be registered. You will also specify the access authority (see below) when registering the name.
- There are limitations on the number of simultaneous connections or simultaneous uses of the DX from the PC (see section 2.1).

Granting access authority

This function provides access authority (user level) to operate the DX for the registered users. For example, this prevents user B (user level) from changing the measurement conditions that were set by user A (administrator level).

- There are two user levels on the DX, user and administrator.
- One administrator and six users can be registered.

• Administrator

An administrator has the authority to use all setting/measurement server functions, maintenance/test server functions, and FTP server functions.

• User

A user has limited authority to use the setting/measurement server functions, maintenance/test server functions, and FTP server functions. For the limitation of commands, see section 5.2.

- Limitations on the use of the setting/measurement server

The user cannot change settings that would change the DX's operation. Measurement and setup data can be output.

- Limitations on the use of the maintenance/test server

The user cannot disconnect a connection between another PC and the DX. The connection between the PC that the user is operating and the DX can be disconnected.

- Limitations on the use of the FTP server

You cannot save files to the external storage medium of the DX or delete files on it. Files can be retrieved from the server.

Communication timeout

This function drops the connection if no data transfer is detected between the PC and the DX over a predetermined period of time. This applies to data transfer at the application level only (see section 1.1). For example, this function prevents a PC from being connected to the DX indefinitely which would prohibit other users from making new connections for data transfer.

1.2 Explanation of the Functions

Web server

- This function can be used only when communicating via the Ethernet interface.
- The DX screen can be displayed on the browser applications of Microsoft Internet Explorer.
- The following two screens are available:
 - Monitor page: Screen dedicated for monitoring.
 - Operator page: You can switch the DX screen. You can also modify and write messages.

You can set access control (user name and password) on each page.

The screenshot shows the DX screen interface. At the top, there is a status bar with 'Auto Refresh OFF' and 'Zoom 100%'. Below this is a navigation bar with buttons for 'Refresh', 'Alarm Summary', 'All Channels', 'Log', and 'Message'. The main display area is divided into three sections: a waveform graph on the left, a data table in the middle, and a menu on the right. The data table shows values for channels 1 through 6, with values ranging from -0.999 to -1.000. The menu includes options for 'TREND', 'DIGITAL', and 'BAR GRAPH', each with a 'Select Group' dropdown. Below the menu is a circular control with 'DISP/ENTER' in the center and arrow keys around it.

Refreshes the screen automatically
Selects the screen size

Menu

- Refreshes the screen
- Displays the alarm summary
- Displays the measured /computed data
- Displays logs
- Modifies and writes messages

Switches screens

Arrow keys and the DISP/ENTER key

- The screen can be updated at a constant period (approximately 30 s).
- The following information can be displayed.
 - Alarm summary
 - Measured and computed values of all channels
 - Logs (message log, error log, key login/logout log, FTP file transfer log, e-mail log, and Web operation log)
- For the procedure in setting the Web server function, see section 2.9.
- For operations on the monitor page and operator page, see section 2.10.

E-mail transmission

This function can be used only when communicating via the Ethernet interface.

- **Transmitting e-mail messages**
E-mail can be automatically transmitted at the following times. You can specify two groups of destinations and specify the destination for each item. In addition, you can set a header string for each item.
 - **When alarm is active/released**
Notifies the alarm information.
 - **During recovery from a power failure**
Notifies the time of the power failure and the time of recovery.
 - **When memory end is detected (See "Fail/Memory End Function (/F1 Option)" in this section)**
Notifies the detection of memory end.
 - **When an error related to the external storage medium and FTP client occurs**
Notifies the error code and message when an error is detected on the external

storage medium or when the data cannot be saved as the free space on the storage medium is insufficient. In addition, notifies the error code and message such as when data transfer fails using the FTP client function.

- **At the specified time**
Transmits an e-mail message when the specified time is reached. It can be used to confirm that the system including the network and the e-mail transmission function is working properly. You can specify the reference time and the e-mail transmission interval for each destination.
- **When report is created (only on models with the optional computation function (/M1))**
Transmits the report.

For the procedure in setting the e-mail transmission function, see section 2.11.

For the e-mail transmission format, see section 2.13.

For the procedure to start/stop e-mail transmission, see section 2.13.

An example of the scheduled e-mail

From: DX@yokogawa.co.jp	
Date: Sat, 23 Dec 2000 01:00:09 +0900 (JST)	
Subject: (DX) Periodic_data	Subject
To: Admin@good.co.jp	
LOOP1	Header 1
Scheduled	Header 2
Periodic data.	
<Host name>	
DX	
<Time>	
Dec.23 01:00:01	

- **Testing e-mail transmission**
 - You can send a test message from the DX to the destination to check e-mail transmissions.
 - You can confirm the result of the e-mail transmission test on the e-mail log screen.
 - For the procedure in using this function, see section 2.12.

Other functions

Confirming the connection status of the Ethernet interface

- The connection status of the Ethernet interface can be confirmed on the rear panel and on the screen of the DX.
- For the display position and the meaning of the indicator, see section 2.4.

Keepalive (Extended function of TCP)

- This function forcibly drops the connection if there are no responses to the test packets that are sent periodically at the TCP level.
- For the configuration required to use this function, see sections 2.3 and 2.7.

Displaying error/communications/FTP/Web operation/E-mail logs

- The operation log can be displayed on the following log screens.
 - Error log screen: Operation errors
 - Communication log screen: Communication input/output
 - FTP log screen: A log of file transfers that were executed using the FTP client function
 - Web operation log screen: Record of operations of the Web server function
 - E-mail log screen: Record of e-mail transmissions.
- For the configuration required to use this function, see section 2.8.

2.1 Ethernet Interface Specifications

Basic Specifications

Electrical and mechanical specifications	Conforms to IEEE 802.3 (Ethernet frames conform to the DIX specifications.)
Transmission medium type	10BASE-T
Protocol	TCP, IP, UDP, ICMP, ARP

The maximum number of connections and the number of simultaneous uses

The following table indicates the number of simultaneous uses (number of users that can use the function simultaneously), the maximum number of connections, and the port number for each function.

Function	Maximum Number of Connections	Number of Simultaneous Uses		Port Number* ¹ (Fixed)
		Administrator	User	
Setting/ measurement server	3	1	2* ²	34260/tcp
Maintenance/ test server	1	1	1* ²	34261/tcp
FTP server	2	2	2* ²	21/tcp
Instrument information server	–	–	–	34264/udp

*¹ Port numbers are fixed.

*² There are user limitations. For details, see "Granting Access Authority" in section 1.2.

2.2 Connecting the Ethernet Interface

When connecting only the DX and a PC

Connect the DX and the PC via a HUB as in the following figure.

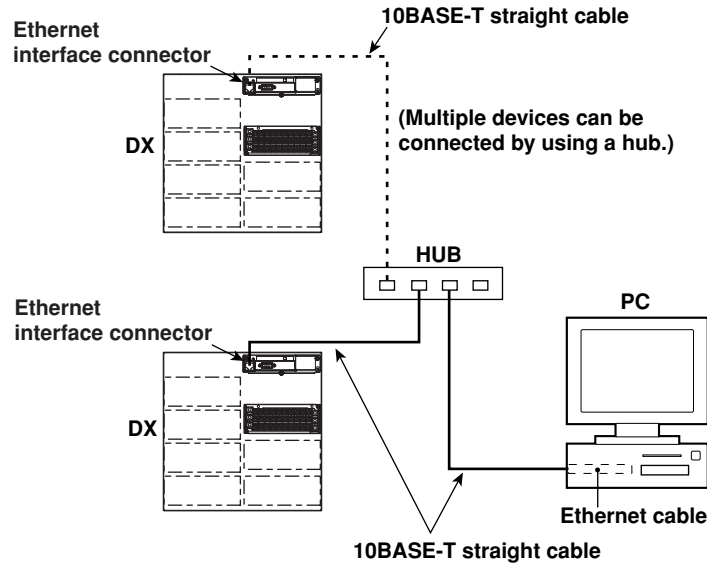

When connecting to a preexisting network

The following figure illustrates an example in which the DX and a PC are connected to the network. When connecting the DX or the PC to a preexisting network, the transfer rate, connector type, etc. must be matched. For details, consult your system or network administrator.

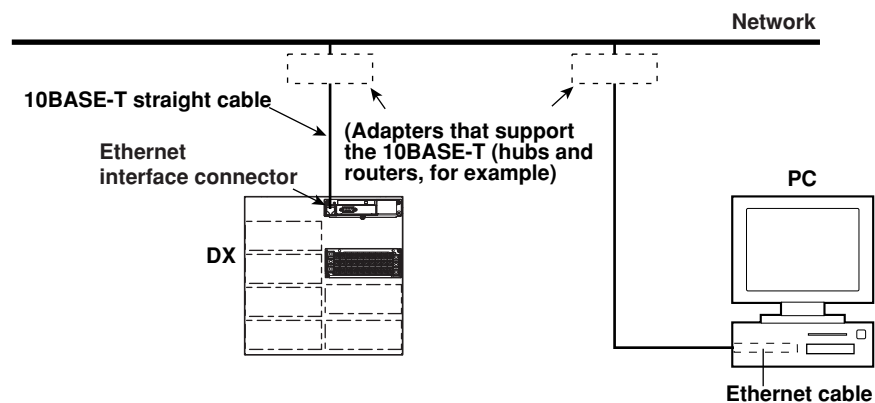

Note

- Depending on the reliability of the network or the volume of network traffic, all the transferred data may not be retrieved by the PC.
- Communication performance deteriorates if multiple PCs access the recorder simultaneously.

2.3 Configuring the Ethernet Interface

Explanation

The following configurations must be made in order to use the Ethernet communication functions of the DX.

Setting the IP address, subnet mask, default gateway, and DNS

Confirm the settings such as the IP address, subnet mask, default gateway, and DNS with the administrator of the system or network on which the recorder is to be used.

- **IP address**
 - Set the IP address to assign to the DX. The default setting is “0.0.0.0.”
 - The IP address is used to distinguish between the various devices connected to the Internet when communicating using the TCP/IP protocol. The address is a 32-bit value normally expressed with four values (0 to 255), each separated by a period as in 192.168.111.24.
- **Subnet mask**
 - Specify the mask that is used to determine the network address from the IP address. The default setting is “0.0.0.0.”
 - Set this value according to the system or the network to which the DX belongs. In some cases, this setting may not be necessary.
- **Default gateway**
 - Set the IP address of the gateway (router, etc.) used to communicate with other networks. The default setting is “0.0.0.0.”
 - Set this value according to the system or the network to which the DX belongs. In some cases, this setting may not be necessary.
- **DNS (Domain Name System)**

You must set the DNS, if you are using a host name to specify the destination server of the file transfer on an FTP client or the server of the e-mail recipient.

 - * The DNS is a system that correlates the host name/domain name to the IP address. The host name/domain name can be used instead of the IP address when accessing the network. The DNS server manages the database that contains the host name/domain name and IP address correlation.
 - **DNS server**
 - Set the IP address of the DNS server. The default setting is “0.0.0.0.”
 - Up to two DNS servers can be specified (primary and secondary). If the primary DNS server is down, the secondary server is used to search the host name/domain name and IP address.
 - **Host name**

Set the DX’s host name using up to 64 alphanumeric characters.
 - **Domain name**
 - Set the network domain name to which the DX belongs using up to 64 alphanumeric characters.
 - When the destination server of the file transfer or the server of the e-mail recipient is looked up using the DNS server, this domain name is appended to the host name as a possible domain name if it is omitted . The destination name (server name) becomes the “FTP server name” (see section 2.5) or the “SMTP server name” (see section 2.11).

2.3 Configuring the Ethernet Interface

- Domain suffix

If the IP address corresponding to the “domain name,” described in the previous paragraph, is not found on the DNS server, then it may be that the system is configured to use another domain name. In this case, the domain suffix is specified, so that this domain name is searched after the “domain name” specified in the previous paragraph is searched.

- Set the domain suffix using up to 64 alphanumeric characters.
- Up to two domain suffixes can be specified (primary and secondary).

Selecting the communication interface used to output the data in the internal memory and the files on the external storage medium

- Using output commands (ME/MI/MO commands), select the communication interface used to output the data in the internal memory (display data, event data, TLOG data, manual sampled data, and report data) and the files on the external storage medium. Since these commands cannot be used on Ethernet communications and serial communications simultaneously, you must select either one.
- When using Ethernet communications, select [Ethernet].

Storing the settings

To activate the settings made in the basic setting mode, the settings must be saved. Otherwise, the settings return to the previous values.

Procedure

For the basic flow of operations, see “Flow of Operation using the Operation Keys” on page vi. For the procedures related to entering character strings and values, see the DX100/DX200 User’s Manual (IM04L01A01-01E/IM04L02A01-01E).

1. Press the MENU key to display the setting menu.
2. Press the FUNC key for approximately 3 s to display the basic setting menu.
3. Press the [#10 (Communication)](DX100) or [#6 (Communication)](DX200) soft key to display the communication function setting menu.
4. Press the [#1 (Ethernet (IP Address))](DX100) or [#1 (Ethernet, Serial)](DX200) soft key to display the communication (Ethernet, serial) menu.

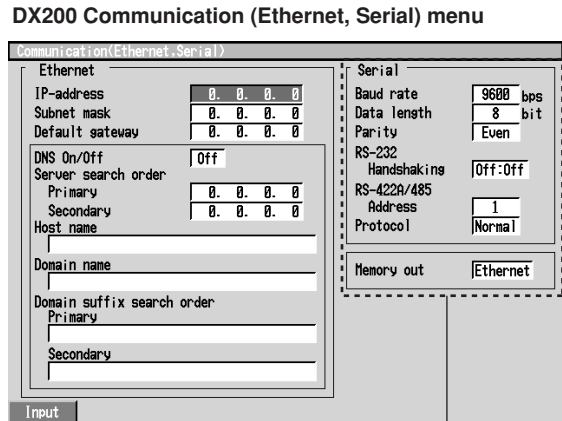
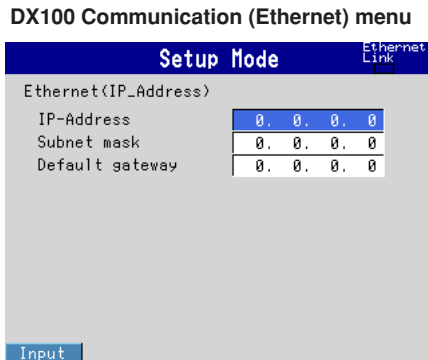

These setting items appears on the models with the serial communication function (/C2, /C3).

Setting the IP address

5. Press the arrow key to move the cursor to the [IP-address] box.



6. Press the [Input] soft key to display the entry box.



7. Enter the IP address of the DX in the entry box.
8. Press the DISP/ENTER key. The entered value is set in the [IP-address] box.

Setting the subnet mask

Set this value according to the system or the network to which the DX belongs. If this setting is not necessary, go to “Setting the default gateway.”

9. Press the arrow key to move the cursor to the [Subnet mask] box.



10. Press the [Input] soft key to display the entry box.



2.3 Configuring the Ethernet Interface

11. In the entry box, enter the subnet mask of the network to which the DX belongs.
12. Press the DISP/ENTER key. The entered value is set in the [Subnet mask] box.

Setting the default gateway

Set this value according to the system or the network to which the DX belongs. If this setting is not necessary, go to “Setting the DNS (Domain Name System).”

13. Press the arrow key to move the cursor to the [Default gateway] box.

Ethernet				
IP-address	0.	0.	0.	0
Subnet mask	0.	0.	0.	0
Default gateway	0.	0.	0.	0

14. Press the [Input] soft key to display the entry box.

Input

--

15. In the entry box, enter the IP address of the default gateway of the network to which the DX belongs.

16. Press the DISP/ENTER key. The entered value is set in the [Default gateway] box.

For DX100, confirm the new settings pressing the DISP/ENTER key. To cancel, press the ESC key.

For detailed operations regarding confirmation and cancellation, see “Flow of Operation using the Operation Keys” on page vi.

Setting the DNS (Domain Name System)

Set the DNS, if you are using a host name to specify the destination server of the file transfer on an FTP client or the server of the e-mail recipient.

If the DNS is not going to be used, go to step 39 (for models with the serial communication function) or step 41 (for models without the serial communication function).

For DX100, when settings are confirmed by procedure 16, press the ESC key to return to the communication function setting menu, and then press the [#2 (Ethernet (DNS))] soft key to display the communication (DNS) menu.

• Select whether or not to use the DNS (ON/OFF)

17. Press the arrow key to move the cursor to the [DNS On/Off] box.

Default gateway	0.	0.	0.	0
DNS On/Off	Off			
Server search order				

18. Press either the [On] or [Off] soft key. When using the DNS, select [ON] and perform steps 19 through 38. Otherwise, select [Off] (you can skip steps 19 through 38).

On	Off
----	-----

--	--

• Setting the primary DNS server address

19. Press the arrow key to move the cursor to the [Primary] box under server search order.

Server search order				
Primary	0.	0.	0.	0
Secondary	0.	0.	0.	0

20. Press the [Input] soft key to display the entry box.

Input

--

21. Enter the primary DNS server address in the entry box.

22. Press the DISP/ENTER key. The entered value is set in the [Primary] box.

- **Setting the secondary DNS server address**

Set this value when using the secondary DNS server in the system or the network to which the DX belongs. If this setting is not necessary, go to step 25.

23. Press the arrow key to move the cursor to the [Secondary] box under server search order.

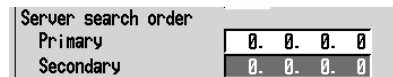

24. Set the secondary DNS server address using the same method from steps 20 through 22.

- **Setting the DX's host name**

25. Press the arrow key to move the cursor to the [Host name] box.

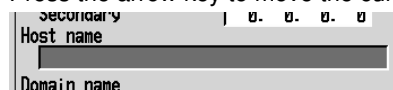

26. Press the [Input] soft key to display the entry box.



27. Enter the DX's host name in the entry box.

28. Press the DISP/ENTER key. The entered string/value is set in the [Host name] box.

- **Setting the domain name to which the DX belongs**

29. Press the arrow key to move the cursor to the [Domain name] box.

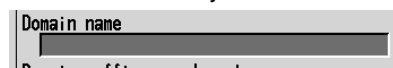

30. Press the [Input] soft key to display the entry box.



31. Enter the DX's domain name in the entry box.

32. Press the DISP/ENTER key. The entered string/value is set in the [Domain name] box.

- **Setting the primary domain suffix**

Set this value when the domain suffix is necessary. Otherwise, go to step 39 (for models with the serial communication function) or step 41 (for models without the serial communication function).

33. Press the arrow key to move the cursor to the [Primary] box under Domain suffix search order.

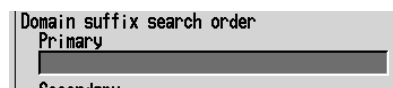

34. Press the [Input] soft key to display the entry box.



2.3 Configuring the Ethernet Interface

35. Enter the primary domain suffix in the entry box.
36. Press the DISP/ENTER key. The entered value is set in the [Primary] box.

- **Setting the secondary domain suffix**

Set this value when the secondary domain suffix exists. If this setting is not necessary, go to step 39 (for models with the serial communication function) or step 41 (for models without the serial communication function).

37. Press the arrow key to move the cursor to the [Secondary] box under Domain suffix search order.

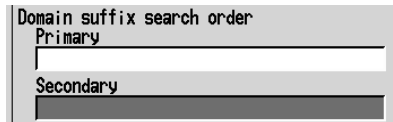

38. Set the secondary domain suffix in the same fashion as in steps 34 to 36.

Selecting the communication interface used to output the data in the internal memory and the files on the external storage medium

The "Memory output" is displayed when the serial communication function is specified.

39. Press the arrow key to move the cursor to the [Memory out] box.



40. Press either the [Ethernet] or the [Serial] soft key. Press the [Ethernet] soft key when using Ethernet communications.



Confirming/Canceling the new settings

41. To confirm the new settings, press the DISP/ENTER key. To cancel, press the ESC key.

For detailed operations regarding confirmation and cancellation, see "Flow of Operation using the Operation Keys" on page vi.

Storing the new settings

42. Press the ESC key several times to display the basic setting menu.
43. Pressing the [End] soft key to display a dialog box which you select whether or not to store the new settings.



44. Select the [Yes] to store the new settings, the [No] to discard them, or the [Cancel] to return to the basic setting menu by pressing the arrow key. Then, press the DISP/ENTER key.

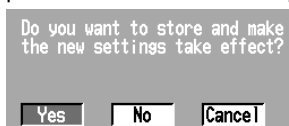

2.4 Checking the Connection Status of the Ethernet Interface

Checking the connection status using the rear panel

The connection status of the Ethernet interface can be confirmed with the indicator that is located to the upper right of the Ethernet connector on the DX.

Indicator	Connection Status of the Ethernet Interface
On (green)	The Ethernet interface is electrically connected.
Blinking (green)	Transmitting data
Off	The Ethernet interface is not electrically connected.

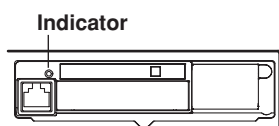

(Rear Panel)

Checking the connection using the recorder's screen

Checking using the status display of the screen

The connection status of the Ethernet interface can be checked using the indicator located on the right hand side of the status display section of the basic setting menu. The basic setting menu is displayed by pressing the FUNC key for approximately 3 s after pressing the MENU key to display the setting menu.

Indicator	Connection Status of the Ethernet Interface
On (green)	The Ethernet interface is electrically connected.
Off	The Ethernet interface is not electrically connected.



Checking using the display section located at the upper right corner of the communication log screen

The connection status of the Ethernet interface can be checked using the indicator located at the upper right corner of the communication log screen. For the procedures on how to display the communication log, see section 2.8.

Indicator	Connection Status of the Ethernet Interface
On (green)	The Ethernet interface is electrically connected.
Off	The Ethernet interface is not electrically connected.



2.5 Setting the FTP Client (Automatic Transfer of Display/Event/Report Data Files)

Explanation

By setting this function, the display/event and report data files that are created in the internal memory can be automatically transferred using FTP when the files are created. Note that the Ethernet interface must be configured beforehand (see section 2.3).

Selecting the files to transfer

- You can select whether or not to automatically transfer the display/event data file and the report data file. The default setting is “Off.”
- When the method to save the data is set to “Auto,” the data files are automatically transferred at appropriate times to the FTP destination described in the next section.
 - Display data file: Data files are automatically transferred at auto save intervals or at the specified date and time.
 - Event data file: Data files are automatically transferred when data length of data is written or at every specified date and time*.
 - * Auto transfer at every specified date and time is allowed only during the “free” mode. For information on the “free” mode, see the DX100/DX200 User’s Manual (IM04L01A01-01E/IM04L02A01-01E).
- Report data file: Automatically transferred when reports are created.

Note

- For details related to saving data to the external storage medium and the auto save interval, see the DX100/DX200 User’s Manual (IM04L01A01-01E/IM04L02A01-01E).
- When the method to save the data is set to “Manual,” auto transfer does not take place. You can still output the display/event/report data files using commands.
- For the format of the report data file, see the DX100/DX200 User’s Manual (IM04L01A01-01E/IM04L02A01-01E). However, the report data file to be transferred is divided by every timeout.
- If a file with the same name is detected at the destination, the file is transferred with the last character (8th character) of the file name changed. For details on the file name, see section 8.1 in the DX100/DX200 User’s Manual IM04L01A01-01E/IM04L02A01-01E.
Example: If the file to be transferred named “X0212000.DDS” exists at the destination, the file name is changed to “X0212001.DDS” before it is transferred.
(However, if the firmware version number of the DX is less than 4.05, the above behavior does not apply. In this case, the file is overwritten without any warning messages.)

Setting the FTP connection

Confirm the settings such as the primary and secondary FTP servers, port number, login name, password, account, PASV mode, and initial path with your system or network administrator.

- **Setting the primary and secondary servers**
Specify the primary and secondary file transfer destinations (FTP servers) as described in the previous close. When the primary FTP server is down, the data are transferred to the secondary FTP server.

2.5 Setting the FTP Client (Automatic Transfer of Display/Event/Report Data Files)

- **FTP server name**

Set the FTP server name using up to 64 alphanumeric characters.

- When the DNS is being used, the host name can be used to specify the server name.
- For DNS settings, see section 2.3.
- You can also specify the IP address. In this case, DNS is not necessary.

- **Port number**

Set the port number of the destination FTP server in the range from 1 to 65535. The default setting is 21.

- **Login name**

Set the login name to use when accessing the FTP server. Up to 32 alphanumeric characters can be used.

- **Password**

Set the password to use when accessing the FTP server. Up to 32 alphanumeric characters can be used.

- **Account**

Set the account (the ID number) to use when accessing the FTP server. Up to 32 alphanumeric characters can be used.

- **PASV mode**

When using the DX behind a firewall that requires the PASV mode, turn this mode "On." A firewall is a security feature on a router which is used to prevent undesired intrusion into the network from outside parties.

- **Initial path**

Set the destination directory for the file transfer using up to 64 alphanumeric characters. The directory delimiter varies depending on the FTP server.

Example: When transferring files to the "data" directory in the "home" directory of an FTP server on a UNIX file system, use the forward slash "/" as the directory delimiter:

```
/home/data
```

Note

If the file transfer to both the primary and the secondary servers fails, the DX aborts the file transfer. When the connection to the destination is recovered, the DX transfers the data files that were not transferred along with the new data file. However, due to the limitation of the internal memory, files that are overacquired before they are transferred are lost. For details related to the acquiring operation to the internal memory, see the DX100/DX200 User's Manual (IM04L01A01-01E/IM04L02A01-01E).

Storing the settings

To activate the settings made in the basic setting mode, the settings must be saved. Otherwise, the settings return to the previous values.

2.5 Setting the FTP Client (Automatic Transfer of Display/Event/Report Data Files)

Procedure

For the basic flow of operations, see “Flow of Operation using the Operation Keys” on page vi. For the procedures related to entering character strings and values, see the DX100/DX200 User’s Manual (IM04L01A01-01E/IM04L02A01-01E).

1. Press the Menu key to display the setting menu.
2. Press the FUNC key for approximately 3 s to display the basic setting menu.
3. Press the [#10 (Communication)](DX100) or [#6 (Communication)](DX100/DX200) soft key to display the communication function setting menu.
4. Press the [#3 (FTP transfer file)](DX100) or [#2 (FTP Client)](DX200) soft key to display the Communication (FTP client) menu.

DX100 Communication (FTP transfer file)

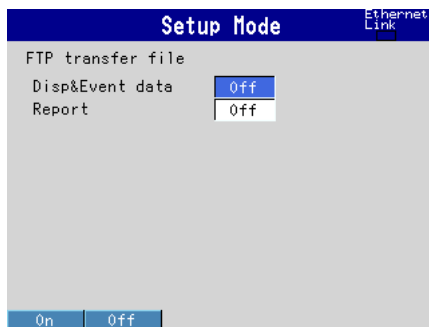

DX200 Communication (FTP client)

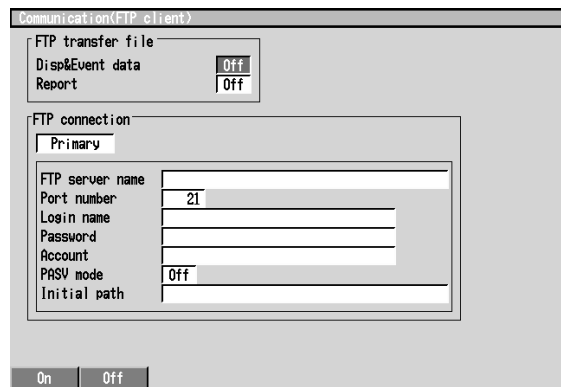

Selecting the files to be transferred

- **Selecting whether or not to transfer the display and event data files (ON/OFF)**

5. Press the arrow key to move the cursor to the [Disp&Event data] box.

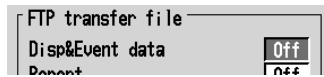

6. Press either the [On] or [Off] soft key.

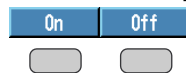

- **Selecting whether or not to transfer the report data file (ON/OFF)**

7. Press the arrow key to move the cursor to the [Report] box.

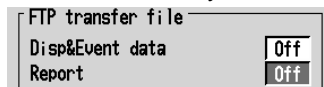

8. Press either the [On] or [Off] soft key.

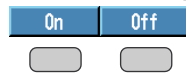

For DX100, confirm the new settings pressing the DISP/ENTER key. To cancel, press the ESC key.

For detailed operations regarding confirmation and cancellation, see “Flow of Operation using the Operation Keys” on page vi.

Setting the primary FTP server

For DX100, when settings are confirmed by procedure 8, press the ESC key to return to the communication function setting menu, and then press the [#4 (FTP connection)] soft key to display the communication (FTP connection) menu.

9. Press the arrow key to move the cursor to the [FTP connection] box.



10. Press the [Primary] soft key.

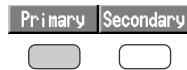

• **Setting the FTP server name**

11. Press the arrow key to move the cursor to the [FTP server name] box.

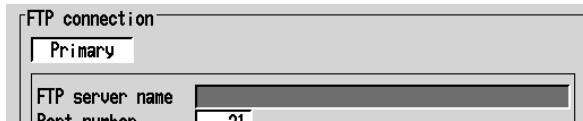

12. Press the [Input] soft key to display the entry box.



13. Enter the primary FTP server name in the entry box. Generally, the IP address is entered. However, if DNS is being used, the FTP server's host name can also be specified.

14. Press the DISP/ENTER key. The entered string/value is set in the [FTP server name] box.

• **Setting the FTP server's port number**

15. Press the arrow key to move the cursor to the [Port number] box.

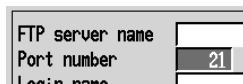

16. Press the [Input] soft key to display the entry box.



17. Enter the port number of the primary FTP server in the entry box.

18. Press the DISP/ENTER key. The entered value is set in the [Port number] box.

• **Setting the login name used when accessing the FTP server**

19. Press the arrow key to move the cursor to the [Login name] box.



20. Press the [Input] soft key to display the login name entry box.



2.5 Setting the FTP Client (Automatic Transfer of Display/Event/Report Data Files)

21. Enter the login name that is used when accessing the primary FTP server in the entry box.
22. Press the DISP/ENTER key. The entered string/value is set in the [Login name] box.

- **Setting the password used when accessing the FTP server**

23. Press the arrow key to move the cursor to the [Password] box.

Login name	
Password	
Account	

24. Press the [Input] soft key to display the entry box.

Input

25. Enter the password that is used when accessing the primary FTP server in the entry box.
26. Press the DISP/ENTER key. The entered string/value is set in the [Password] box.

- **Setting the account used when accessing the FTP server**

27. Press the arrow key to move the cursor to the [Account] box.

Password	
Account	
PASV mode	Off

28. Press the [Input] soft key to display the entry box.

Input

29. Enter the account that is used when accessing the primary FTP server in the entry box.
30. Press the DISP/ENTER key. The entered string/value is set in the [Account] box.

- **Enabling (On)/Disabling (Off) the PASV mode**

31. Press the arrow key to move the cursor to the [PASV mode] box.

Account	
PASV mode	Off
Initial path	

32. Press either the [On] or [Off] soft key.

- **Setting the initial path (file transfer destination directory)**

33. Press the arrow key to move the cursor to the [Initial path] box.

PASV mode	Off
Initial path	

2.5 Setting the FTP Client (Automatic Transfer of Display/Event/Report Data Files)

34. Press the [Input] soft key to display the entry box.



35. Enter the file transfer destination directory in the entry box.

36. Press the DISP/ENTER key. The entered string/value is set in the [Initial path] box.

Setting the secondary FTP server

Set the secondary FTP server when specifying a secondary file transfer destination. If you are not using the secondary FTP server, go to step 40.

37. Press the arrow key to move the cursor to the [FTP connection] box.

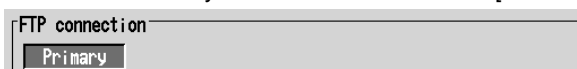

38. Press the [Secondary] soft key.



39. Set the secondary FTP server using the same method from steps 11 through 36.

Confirming/Canceling the new settings

40. To confirm the new settings, press the DISP/ENTER key. To cancel, press the ESC key.

For detailed operations regarding confirmation and cancellation, see "Flow of Operation using the Operation Keys" on page vi.

Storing the new settings

41. Press the ESC key several times to display the basic setting menu.
42. Pressing the [End] soft key to display a dialog box which you select whether or not to store the new settings.



43. Select the [Yes] to store the new settings, the [No] to discard them, or the [Cancel] to return to the basic setting menu by pressing the arrow key. Then, press the DISP/ENTER key.

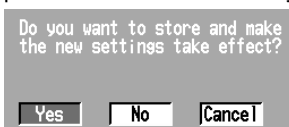

2.6 Performing the FTP Test

Explanation

You can check whether or not files can be transferred via the Ethernet interface by transferring a test file from the DX to the FTP server that was configured in section 2.5.

Items to check before performing this test

- Correctly connect the Ethernet cable. For the connection procedures, see section 2.2.
- Check that the Ethernet interface configuration is correct. For the procedures, see section 2.3 and 2.5.

When configuring Ethernet related settings, check them with the administrator of the system or network on which the DX is to be used.

Checking the FTP test results

- When you perform the FTP test, the test file is transferred to the initial path on the destination FTP server that was specified in section 2.5. After the FTP test completes, check whether or not the test file was received on the FTP server
- The result of the FTP test can be confirmed by displaying the FTP log (displayed on the DX200 (see section 2.8)) or Web browser screen (see section 2.10) or by outputting the result using the FL command (see section 5.8).

Procedure

Performing the FTP test.

1. Press the FUNC key to display the FUNC menu. The construction of the FUNC menu varies depending on the basic settings and options.
2. Press the [FTP test] soft key to display a menu used to select the destination on which the FTP test to be performed.



3. Press either the [Primary] or [Secondary] soft key. The FTP test is performed on the specified FTP server.



2.7 Setting the Login/Timeout for Ethernet Communications

Explanation

By setting the login and timeout, you can achieve the following:

- Prevent invalid access to the DX from the network.
- Grant authority in operating the DX via Ethernet communications.
- Disconnect connections when there are no data transfers over a predetermined time period.

Note that the Ethernet interface must be configured beforehand (see section 2.3).

Enabling/Disabling the login function

If the login function is enabled, only users that are registered can login to the DX.

User registration

• **Selecting the user level**

Select either of the user levels, administrator or user.

• Administrator (admin)

One administrator can be registered. An administrator has the authority to use all setting/measurement server, maintenance/test server, and the FTP server functions.

• User (user1 to user6)

Six user can be registered. A user has limited authority to use the setting/measurement server functions, maintenance/test server functions, and FTP server functions. For the limitation of commands, see section 5.2.

• Limitations on the use of the setting/measurement server

The user cannot change settings that would change the DX's operation. Measurement and setup data can be output.

• Limitations on the use of the maintenance/test server

The user cannot disconnect a connection between another PC and the DX. The connection between the PC that the user is operating and the DX can be disconnected.

• Limitations on the use of the FTP server

You cannot save files to the external storage medium of the DX or delete files on it. Files can be retrieved from the server.

• **Selecting whether or not to register the user (On/Off)**

• On

Registers the user. You can specify the user name and password for the login.

• Off

Does not register the user.

• **Setting the user name**

• Set the user name using up to 16 alphanumeric characters.

• Each user name must be unique.

• Since the word "quit" is reserved as a command on the instrument, the user name "quit" is not allowed.

• **Setting the password**

Set the password using up to 6 alphanumeric characters.

2.7 Setting the Login/Timeout for Ethernet Communications

Note

- The relationship between the login function and the user name that is used when accessing the DX is as follows.
 - **When the login function is set to “Enable”**
 - The registered user name and password can be used to login to the DX.
 - The user level is the level that was specified when the user name was registered.
 - **When the login function is set to “Disable”**
 - The user name “admin” can be used to login to the DX as an administrator. Password is not necessary.
 - The user name “user” can be used to access the DX as a user. Password is not necessary.
 - When the DX is an FTP server, the user name “anonymous” has a special role.
 - **When the login function is set to “Enable”**
 - If a user name “anonymous” is registered in the DX, this user name can be used to login to the DX.
 - Password is not necessary (login is possible regardless of whether or not the password is specified).
 - The user level is the level of the user who specified the user name “anonymous.”
 - **When the login function is set to “Disable”**
 - The user name “anonymous” can be used to login to the DX.
 - Password is not necessary (login is possible regardless of whether or not the password is specified).
 - The user level is “User.”
 - There are limitations on the number of simultaneous connections or simultaneous uses of the DX from the PC (see section 2.1).
 - For a description of the login process of the setting/measurement server and maintenance/test server, see appendix 7.
-

Communication timeout

- **Enabling/Disabling the timer (ON/OFF)**
 - **On**

The connection is dropped if no data transfer is detected over a predetermined period of time. This applies to data transfer at the application level only (see section 1.1).
 - **Off**

Communication timeout is disabled.
- **Setting the timeout time**

When the communication timeout is enabled and if no data transfer is detected over the time period specified here, the connection is dropped.
Range: 1 to 120 minutes

Enabling/Disabling keepalive (On/Off)

- **On**

If there is no response to the test packet that is periodically transmitted (every 30 s) at the TCP level, the connection is dropped.
- **Off**

Keepalive is disabled.

Storing the settings

To activate the settings made in the basic setting mode, the settings must be saved. Otherwise, the settings return to the previous values.

Procedure

For the basic flow of operations, see “Flow of Operation using the Operation Keys” on page vi. For the procedures related to entering character strings and values, see the DX100/DX200 User’s Manual (IM04L01A01-01E/IM04L02A01-01E).

1. Press the Menu key to display the setting menu.
2. Press the FUNC key for approximately 3 s to display the basic setting menu.
3. Press the [#10 (Communication)](DX100) or [#6 (Communication)](DX200) soft key to display the communication function setting menu.
4. Press the [#5 (Control (Login, Timeout))](DX100) or [#3 (Control (Login, Timeout))](DX200) soft key to display the Communication (Control -Login, Time out-) menu.

DX100 Communication (Control (Login, Time out))

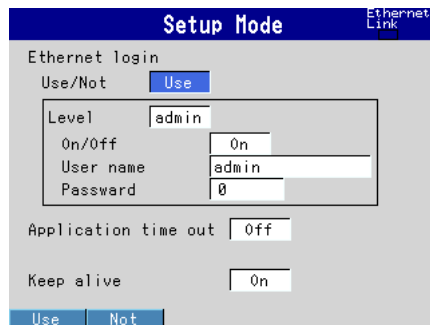

DX200 Communication (Control -Login, Time out)

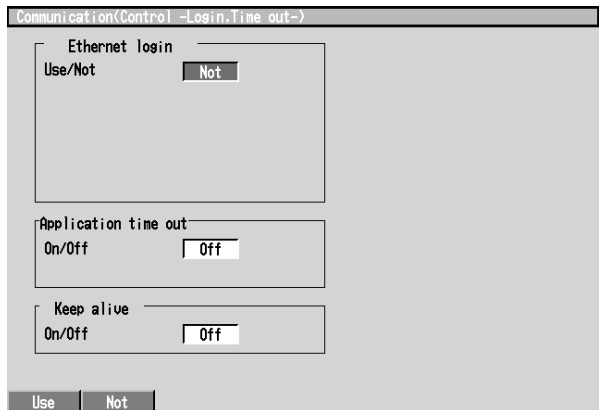

Enabling/Disabling the login function of the DX

5. Press the arrow key to move the cursor to the [Use/Not] box under Ethernet login.

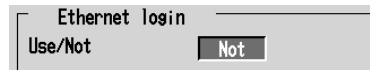

6. Press either the [Use] or [Not] soft key. If you select [Use], go to step 7. If you select [Not], go to step 20.



Registering users

- **Selecting the user level for the registered user**

7. Press the arrow key to move the cursor to the [Level] box.

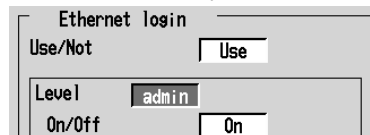

8. Press one of the keys from [admin] to [user6] to select the user level. To set the user level to administrator, select [admin]. To set the user level to user, select [user1] to [user6].

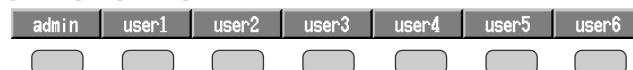

2.7 Setting the Login/Timeout for Ethernet Communications

- **Selecting whether or not to register the user (On/Off)**

9. Press the arrow key to move the cursor to the [On/Off] box under Level.

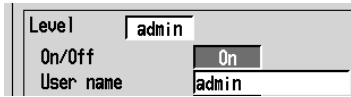

Level	admin
On/Off	On
User name	admin

10. Press either the [On] or [Off] soft key. If you select [On], go to step 11. If you select [Off], go to step 19.

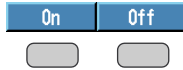

On	Off
----	-----

- **Setting the user name**

11. Press the arrow key to move the cursor to the [User name] box.



On/Off	On
User name	admin
Password	[]

12. Press the [Input] soft key to display the entry box.



Input

13. In the box, enter the user name for the user at the specified level.

14. Press the DISP/ENTER key. The entered string/value is set in the [User name] box.

- **Setting the password**

15. Press the arrow key to move the cursor to the [Password] box.



User name	admin
Password	[]

16. Press the [Input] soft key to display the entry box.



Input

17. In the box, enter the password for the user.

18. Press the DISP/ENTER key. The entered string/value is set in the [Password] box.

19. To register another user, repeat steps 7 to 18.

Setting the communication timeout

- **Enabling/Disabling communication timeout (On/Off)**

20. Press the arrow key to move the cursor to the [On/Off] box under communication timeout.

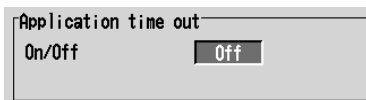

Application time out	
On/Off	Off

21. Press either the [On] or [Off] soft key. If you select [On], go to step 22. If you select [Off], go to step 26.



On	Off
----	-----

- **Setting the communication timeout time**

22. Press the arrow key to move the cursor to the [Time] box.

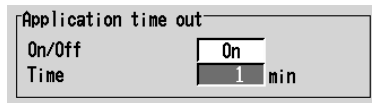

23. Press the [Input] soft key to display the entry box.



24. In the box, enter the communication timeout time.

25. Press the DISP/ENTER key. The entered value is set in the [Time] box.

Enabling/Disabling keepalive (On/Off)

26. Press the arrow key to move the cursor to the [On/Off] box under keepalive.



27. Press either the [On] or [Off] soft key.

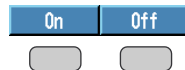

Confirming/Canceling the new settings

28. To confirm the new settings, press the DISP/ENTER key. To cancel, press the ESC key.

For detailed operations regarding confirmation and cancellation, see "Flow of Operation using the Operation Keys" on page vi.

Storing the new settings

29. Press the ESC key several times to display the basic setting menu.

30. Pressing the [End] soft key to display a dialog box which you select whether or not to store the new settings.



31. Select the [Yes] to store the new settings, the [No] to discard them, or the [Cancel] to return to the basic setting menu by pressing the arrow key. Then, press the DISP/ENTER key.

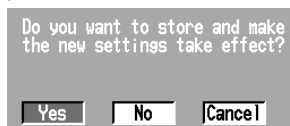

2.8 Displaying the Log Screen of the Error, Communication, and FTP

Explanation

Displaying the error log

A log of operation errors is displayed on the error log screen. Up to the last 50 operation errors are logged. When the number of log entries exceeds 50, room is made by clearing the oldest entries. For the meanings of the error messages, see appendix 6.

<002/002>	Time	No.	Message
Jan. 06. 2000	06:12:01	282	"FTP control connection error."
Jan. 06. 2000	06:12:01	210	"Media has not been inserted."

↑ Error code
 ↑ Error message
 DX100: up to 23 characters
 DX200: up to 48 characters
 ",," indicates the message has characters that are not displayed.

↑ Date and time when the error occurred

Displaying the communication log

A log of input and output incidents of the communication interface is displayed on the communication log screen. Up to a total of 200 incidents of input and output are logged. When the number of log entries exceeds 200, room is made by clearing the oldest entries. For the meanings of the messages, see "Communication Log" in section 6.2.

<007/007>	Time	ID	User Name	I/O Message	Link
Jan. 06. 2000	18:52:23	1	user	< (Logout)	
Jan. 06. 2000	18:52:23	1	user	> CC 0	
Jan. 06. 2000	18:51:48	1	user	< (259)	
Jan. 06. 2000	18:51:48	1	user	> FD 0,001,010	← Message (up to 20 characters)
Jan. 06. 2000	18:51:41	1	user	< E0	
Jan. 06. 2000	18:51:41	1	user	> B0 0	
Jan. 06. 2000	18:51:37	1	user	< (Login)	

↑ I/O symbol
 (> : input, < : output)

↑ Name of the user that accessed this instrument
 (Name registered in section 2.7)

↑ A number used to identify the user that is connected
 (See "Communication log" in section 6.2.)

↑ Date and time when the access occurred

Displaying the FTP log

A log of file transfers is displayed on the FTP log screen. Up to the last 50 accesses are logged. When the number of log entries exceeds 50, room is made by clearing the oldest entries. For the meanings of the messages, see appendix 6.

<005/005>	Time	No.	Code	Flag	File Name
Jan. 01. 2000	01:50:22	282	HOSTNAME	S	10101500.DDS
Jan. 01. 2000	01:50:22	282	UNREACH	P	10101500.DDS
Jan. 01. 2000	01:49:32			P	10101490.DDS ← File name (8 characters)
Jan. 01. 2000	01:48:51			P	10101480.DDS
Jan. 01. 2000	01:48:27			P	DX_FTPC.TXT

↑ Error code
 ↑ FTP server (P : primary, S : secondary)

↑ Date and time when the file transfer was made

Displaying the Web operation log

You can display a log (record) of the operations carried out using the Web screen on the Web operation log screen. Up to 50 previous operations are logged. Logs that exceed 50 operations are cleared from the oldest ones. For the meaning of the messages, see “Web Operation Log” in section 6.2.

<004/004> Time	Request	No.	Parameter
Jan. 07. 2001 01:19:12	Message	155	2:stop
Jan. 07. 2001 01:18:29	Message		1:start
Jan. 07. 2001 01:18:15	Key		UP
Jan. 07. 2001 01:17:58	Screen		DIGITAL GROUP=1

↑ Date/time ↑ Type ↑ Error code (see appendix 6) ↑ Operation

Displaying the e-mail log

You can display a log (record) of e-mail transmissions on the e-mail log screen. Up to 50 previous e-mail transmissions are logged. Logs that exceed 50 transmissions are cleared from the oldest ones. For the meaning of the messages, see “E-mail Log” in section 6.2.

<010/010> Time	Type	No.	Recipient / Error
Jan. 05. 2000 01:08:58	Error	1+2	Yokogawa Satoh
Jan. 05. 2000 01:08:45	Test	1	Yokogawa
Jan. 05. 2000 01:06:30	Full	1+2	Yokogawa Satoh
Jan. 05. 2000 01:00:01	Time	1	Yokogawa
Jan. 05. 2000 00:26:01	Report	1+2	Yokogawa Satoh
Jan. 05. 2000 00:23:33	Alarm	1	Yokogawa
Jan. 05. 2000 00:23:29	Alarm	1	Yokogawa
Jan. 05. 2000 00:22:00	Test	2	Satoh
Jan. 05. 2000 00:21:51	Test	266	Ethernet cable is not connected.
Jan. 05. 2000 00:19:37	Test	1	Yokogawa

↑ Date/time ↑ Mail type ↑ Error code (see appendix 6) ↑ Recipient No. ↑ Recipient address

Note

- In addition to these logs, there is also a key login log. For details regarding the key login log screen, see the DX100/DX200 User’s Manual (IM04L01A01-01E/IM04L02A01-01E).
- The error/communication/FTP/Web operation/e-mail log data can be output. For the data output format, see section 6.2.

Procedure

Displaying the error log

1. Press the FUNC key to display the FUNC menu. The construction of the FUNC menu varies depending on the basic settings and options.

2. Press the [Log] soft key to display the log screen menu.



3. Press the [Error] soft key to display the error log screen.



Displaying the communication log

1. Press the FUNC key to display the FUNC menu. The construction of the FUNC menu varies depending on the basic settings and options.

2. Press the [Log] soft key to display the log screen menu.



3. Press the [Commu] soft key to display the communication log screen.



Displaying the FTP log

1. Press the FUNC key to display the FUNC menu. The construction of the FUNC menu varies depending on the basic settings and options.

2. Press the [Log] soft key to display the log screen menu.



3. Press the [FTP] soft key to display the FTP log screen.



Displaying the Web operation log

1. Press the FUNC key to display the FUNC menu. The construction of the FUNC menu varies depending on the basic settings and options.

2. Press the [Log] soft key to display the log screen menu.



3. Press the [Web] soft key to display the Web operation log screen.



Displaying the e-mail log

1. Press the FUNC key to display the FUNC menu. The construction of the FUNC menu varies depending on the basic settings and options.

2. Press the [Log] soft key to display the log screen menu.



3. Press the [E-Mail] soft key to display the e-mail log screen.



2.9 Setting the Web Server Function

Explanation

Enabling/Disabling the Web server function

Select Use or Not (don't use).

Page type (type of screen to be displayed)

- **Monitor**

- The screen displayed on the DX is displayed.
- The following information can be displayed.
- Alarm summary
- Measured and computed values of all channels
- Logs (message log, error log, key login log, FTP log, e-mail log, and Web operation log)
- For screen examples, see section 2.10.

- **Operator**

The following operations can be carried out in addition to the functions available on the monitor page.

- Switch the screen on the DX by specifying the screen type (trend, digital, or bar graph) and group.
- Operate the DISP/ENTER key and arrow keys on the DX.
- Set and write a message on the DX.
- For screen examples, see section 2.10.

Monitor page

- **Selecting whether or not to use the monitor page**

- **On**
Display the monitor page on the browser.
- **Off**
Do not use the monitor page.

- **Selecting whether or not to use the access control**

- **On**
Use the access control. You must enter the user name and password to display the monitor page.
- **Off**
Do not use the access control.

- **Setting the user name**

Enter the user name using up to 16 alphanumeric characters.

- **Setting the password**

Set the password using up to six alphanumeric characters.

Operator page

- **Selecting whether or not to use the operator page**

- **On**
Display the operator page on the browser.
- **Off**
Do not use the operator page.

- **Selecting whether or not to use command input**
 - **On**
Use the command to set and write messages.
 - **Off**
Do not use the command to set and write messages.
- **Selecting whether or not to use the access control**
 - **On**
Use the access control. You must enter the user name and password to display the operator page.
 - **Off**
Do not use the access control.
- **Setting the user name**
Enter the user name using up to 16 alphanumeric characters.
- **Setting the password**
Set the password using up to six alphanumeric characters.

Saving the settings

To activate the settings that have been changed in the basic setting mode, the settings must be saved. Otherwise, the settings that existed before the change are activated.

Setting the time difference from GMT

See "Setting the Time Zone" in the DX100/DX200 User's Manual (IM 04L01A01-01E/IM 04L02A01-01E).

2.9 Setting the Web Server Function

Procedure

For the basic flow of operations, see “Flow of Operation using the Operation Keys” on page vi. For the procedures related to entering character strings and values, see the DX100/DX200 User’s Manual (IM04L01A01-01E/IM04L02A01-01E).

1. Press the MENU key to display the setting menu.
2. Press the FUNC key for approximately 3 s to display the basic setting menu.
3. Press the [#11 (Web,E-Mail)](DX100) or [#7 (Web,E-Mail)](DX200) soft key to display the Web and e-mail setting menu.
4. Press the [#1 (Web)] soft key to display the Web menu.

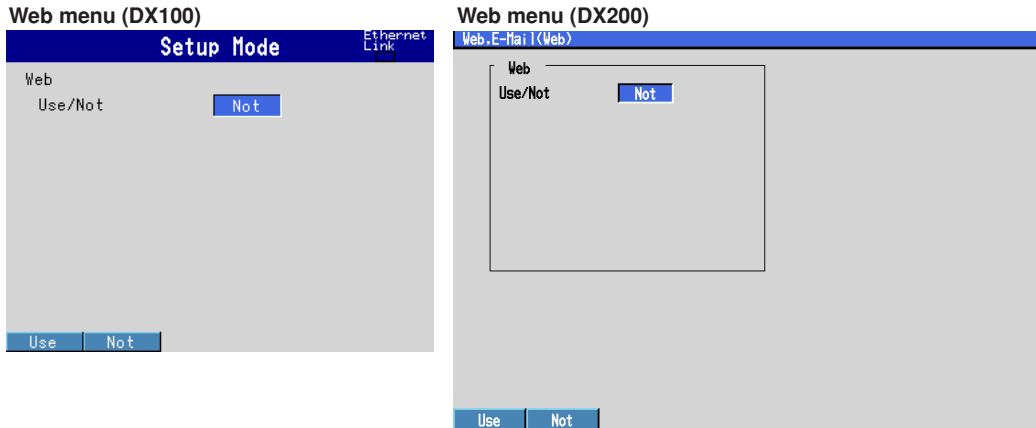

Enabling/Disabling the Web server function

5. Press the arrow key to move the cursor to the [Use/Not] box.

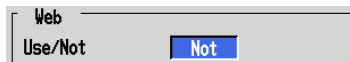

6. Press either the [Use] or [Not] soft key. If you select [Use], go to step 7. If you select [Not], go to step 28.

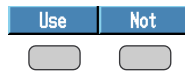

Page type (type of screen to be displayed)

7. Press the arrow key to move the cursor to the [Page type] box.

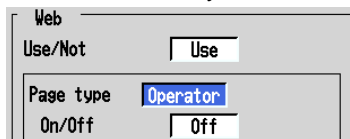

8. Press either the [Operator] or [Monitor] soft key. If you select [Operator], go to step 9. If you select [Monitor], go to step 23.



Operator page

• Selecting whether or not to use the operator page

9. Press the arrow key to move the cursor to the [On/Off] box.

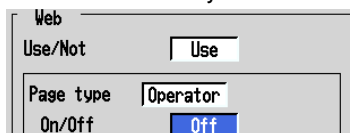

10. Press either the [On] or [Off] soft key. If you select [On], go to step 11. If you select [Off], go to step 28.

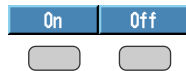

• **Selecting whether or not to use command input**

11. Press the arrow key to move the cursor to the [Command] box.



12. Press either the [On] or [Off] soft key.



• **Selecting whether or not to use the access control**

13. Press the arrow key to move the cursor to the [Access control] box.

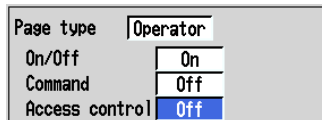

14. Press either the [On] or [Off] soft key. If you select [On], go to step 15. If you select [Off], go to step 28.



• **Setting the user name**

15. Press the arrow key to move the cursor to the [User name] box.

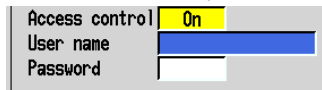

16. Press the [Input] soft key to display the entry box.



17. In the box, enter the user name.

18. Press the DISP/ENTER key. The entered string/value is set in the [User name] box.

• **Setting the password**

19. Press the arrow key to move the cursor to the [Password] box.

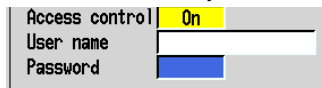

20. Press the [Input] soft key to display the entry box.



2.9 Setting the Web Server Function

21. In the box, enter the password.
22. Press the DISP/ENTER key. The entered string/value is set in the [Password] box.

Monitor page

- **Selecting whether or not to use the monitor page**

23. Press the arrow key to move the cursor to the [On/Off] box.

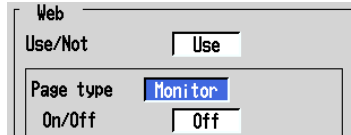

24. Press either the [On] or [Off] soft key. If you select [On], go to step 25. If you select [Off], go to step 28.

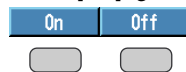

- **Selecting whether or not to use the access control**

25. Set whether use or not use the access control using the same method as steps 13 and 14.

- **Setting the user name**

26. Set whether use or not use the access control using the same method from steps 15 through 18.

- **Setting the password**

27. Set whether use or not use the access control using the same method from steps 19 through 22.

Confirming/Canceling the new settings

28. To confirm the new settings, press the DISP/ENTER key. To cancel, press the ESC key.

For detailed operations regarding confirmation and cancellation, see "Flow of Operation using the Operation Keys" on page vi.

Storing the new settings

29. Press the ESC key several times to display the basic setting menu.
30. Pressing the [End] soft key to display a dialog box which you select whether or not to store the new settings.



31. Select the [Yes] to store the new settings, the [No] to discard them, or the [Cancel] to return to the basic setting menu by pressing the arrow key. Then, press the DISP/ENTER key.

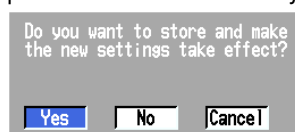

2.10 Using the Monitor Page and Operator Page

Explanation

This section describes how to display the monitor page and operator page and the operation on each page.

Browser application that can be used

Operations have been confirmed on the following browsers.

Microsoft Internet Explorer 4.0 to 5.5

Setting the URL

Set the URL (Uniform Resource Locator) appropriately according to the network environment that you are using. You can access the DX by setting the URL as follows:

• **http://host name.domain name/file name**

- http: Protocol used to access the server. HTTP (HyperText Transfer Protocol).
- Host name.domain name: Host name and domain name of the DX. You can also use the IP address in place of the host name and domain name.
- File name: File name of the monitor page and operator page of the DX.

File name of the monitor page: **monitor.htm**

File name of the operator page: **operator.htm**

If the file name is left out, the monitor page is specified. If the monitor page is not used, however, the operator page is specified.

Example

To display the operator page using Internet Explorer on a PC in the same domain as the DX (the domain name, host name, and IP address are taken to be "good.co.jp," "DX," "and 123.456.789.123," respectively).

Address: **http://DX.good.co.jp/operator.htm** or

Address: **http://123.456.789.123/operator.htm**

Contents on the monitor page

The screenshot shows a web interface for monitoring data. At the top, there are two buttons: "Refresh" (labeled "Refreshes the screen automatically") and "Log" (labeled "Selects the screen size"). Below these are two dropdown menus: "Auto Refresh" (set to OFF) and "Zoom" (set to 100%). A menu bar contains "Refresh", "Alarm Summary", "All Channels", and "Log". The main display area is a 2x3 grid of data points:

1	-0.520	4	-0.540
2	-0.527	5	-0.544
3	-0.532	6	-0.546

Each data point has a status indicator (H or L) and a small 'v' icon. A legend on the right indicates: H (High), L (Low).

Menu

- Refreshes the screen
- Displays the alarm summary
- Displays the measured /computed data
- Displays logs

2.10 Using the Monitor Page and Operator Page

- **Screen displayed by the DX200**

- When the DX is in the operation mode*, the screen displayed on the DX (trend, digital, bar graph, overview, alarm summary, message summary, memory summary, report, or historical trend) is displayed on the monitor page.
- When the DX is in the setting mode* or basic setting mode*, the monitor page cannot be displayed. An error message is displayed.

* For details on the operation mode, setting mode and basic setting mode, see the DX100/ DX200 User's Manual (IM04L01A01-01E/IM04L02A01-01E).

Note

A character “” that is set on the DX is displayed as a character “A” on the Web browser screen.

- **Refreshing the monitor page**

The monitor page can be refreshed automatically or manually.

- **Auto refresh ON**

The monitor page is refreshed at a refresh rate of approximately 30 s.

- **Auto refresh OFF**

Monitor page is not automatically refreshed. You can refresh the page manually. However, the page cannot be refreshed in approximately 30 seconds after the page refreshment.

- **Zooming in or out of the screen**

The DX screen that is displayed on the monitor page can be reduced to 75% in size (DX200) or expanded to 200% (DX100).

- **Displaying the alarm summary**

Displays the alarm summary. Click Refresh to refresh the data.

Refreshes the page.

Channel	Type	Alarm IN Time	Alarm OUT Time
7	2L	Jan.03.2001 00:17:51	
9	2L	Jan.03.2001 00:17:42	
4	1H	Jan.03.2001 00:16:15	Jan.03.2001 00:17:55
2	1H	Jan.03.2001 00:16:15	Jan.03.2001 00:17:55

- **Displaying measured/computed data**

Displays the measured/computed data of all channels (excludes measurement channels set to skip and computation channels set to Off). Click Refresh to refresh the data.

Channel	Alarm status				Reading	Units
	1	2	3	4		
1	H	H	L	L	-0.798	V
2	H	L			-0.797	V
3	R	r			-0.796	V
4	H	H			-0.796	V
5	L	L			-0.795	V

- **Displaying the log**

Displays the message log, error log, FTP log, key login log, Web operation log, and e-mail log. Click Refresh to refresh the data.

Message log

LOG
 MESSAGE

Refresh Close Creation date : Jan.01.2001 02:29:20

Date	Message	User
Jan.01.2001 02:29:03	2 stop	[Communication]
Jan.01.2001 02:28:48	1 start	[Communication]

Selects log type.
Refreshes screen.

Error log

LOG
 ERROR

Refresh Close Creation date : Jan.01.2001 02:29:42

Date	No.	Message
Jan.01.2001 02:25:00	210	Media has not been inserted.
Jan.01.2001 02:25:00	282	FTP control connection error.

FTP log

LOG
 FTP

Refresh Close Creation date : Jan.01.2001 02:29:55

Date	No. / Code	Flag	File Name
Jan.01.2001 02:25:00	282 HOSTNAME	S	10102240.DDS
Jan.01.2001 02:25:00	283 USER	P	10102240.DDS

Key login log

LOG
 KEYLOGIN

Refresh Close Creation date : Jan.01.2001 02:30:12

Date	I/O	No.	User Name
Jan.01.2001 02:27:08	In	01	user1
Jan.01.2001 02:24:10	In	01	user1

E-mail log

LOG
 MAIL

Refresh Close Creation date : Jan.03.2001 00:09:46

Date	Type	No.	Recipient / Error
Jan.03.2001 00:09:36	Alarm	1	Haruo_Saitou
Jan.03.2001 00:09:31	Error	264	1+2 Some recipients' addresses are invalid.

Web operation log

LOG
 WEB

Refresh Close Creation date : Jan.01.2001 02:34:40

Date	Request	No.	Parameter
Jan.01.2001 02:34:28	Key		DISP/ENTER
Jan.01.2001 02:31:23	Key		UP

2.10 Using the Monitor Page and Operator Page

Contents of the operator page

Refreshes the screen automatically
Selects the screen size

Menu

- Refreshes the screen
- Displays the alarm summary
- Displays the measured /computed data
- Displays logs
- Sets and writes messages

Switches screens

Arrow keys and the DISP/ENTER key

The size of the DX200's screen is reduced to 75%.

On the operator page, the following operations can be carried out in addition to the information available on the monitor page.

- **Switching trend, digital, and bar graph displays**
Switch the screen on the DX by specifying the group that will display the trend, numerical, or bar graph display.
- **Operating the DX using the DISP/ENTER key and arrow keys on the operator page**
When the DX is in the operation mode, you can use the DISP/ENTER key and arrow keys on the operator page to carry out the same operations as the DISP/ENTER key and arrow keys on the DX.
- **Setting and writing messages**
Sets the message string for messages 1 through 8 on the DX (16 alphanumeric characters) and, at the same time, display them on the trend display and write them to the internal memory. Existing messages are overwritten.

Using the Monitor Page

This section gives an overview of the operations. Follow the operating procedures on your PC.

Procedure

1. Start the browser and open the monitor page of the DX. If access control is specified, proceed to step 2. Otherwise, proceed to step 5.

Note

Monitor page can be displayed when the DX is in the operation mode. An error message is displayed when the DX is in the setting mode or basic setting mode. For details on the operation mode, setting mode and basic setting mode, see the DX100/DX200 User's Manual (IM04L01A01-01E/IM04L02A01-01E).

Entering the user name and password

• Entering the user name

2. A window appears for you to enter the user name and password. Enter the user name.

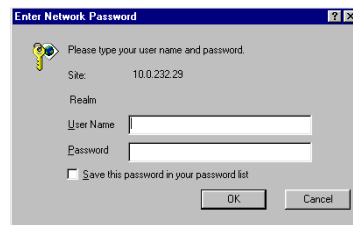

• Entering the password

3. Enter the password. All characters are displayed as asterisks (*).
If the [Save the password] check box is selected, the window appears with the saved password the next time (all characters are displayed as asterisks (*)).
4. Click [OK] to display the monitor page.

Auto refreshing the display

5. Click [Auto Refresh] to specify ON or OFF.

Refreshing the display manually

6. Click [Refresh] in the display menu section to refresh the page.

Zooming in or out of the display

7. Click [Zoom] to specify 100% or 75% (DX200), or 100% or 200% (DX100).

Displaying the alarm summary

8. Click [Alarm summary] in the display menu section to display the alarm summary.
Click [Refresh] to refresh the alarm summary information.
Click [Close] to close the alarm summary window.

2.10 Using the Monitor Page and Operator Page

Displaying measured/computed data

- Click [All channels] in the display menu section to display the measured/computed data.
Click [Refresh] to refresh the measured/computed data.
Click [Close] to close the measured/computed data window.

Displaying the log

- Click [Log] in the display menu section to display the log.
Click the box used to select the log type. The selected type of log is displayed.
Click [Refresh] to refresh the log information.
Click [Close] to close the log window.

Using the Operator Page

This section gives an overview of the operations. Follow the operating procedures on your PC.

Procedure

- Start the browser and open the operator page of the DX.

Note

Operator page can be displayed when the DX is in the operation mode. An error message is displayed when the DX is in the setting mode or basic setting mode. For details on the operation mode, setting mode and basic setting mode, see the DX100/DX200 User's Manual (IM04L01A01-01E/IM04L02A01-01E).

The following operations are the same as the monitor page. See "Using the Monitor Page."

- Entering the user name and password
- Auto refreshing the display
- Refreshing the display manually
- Zooming in or out of the display
- Displaying the alarm summary
- Displaying measured/computed data
- Displaying the log

The followings are the operations only on the operator page.

Setting/modifying and writing messages

When the command for writing messages is enabled (see section 2.9), [Message] appears on the menu.

- Click [Message] in the menu section to display the Message operate window.

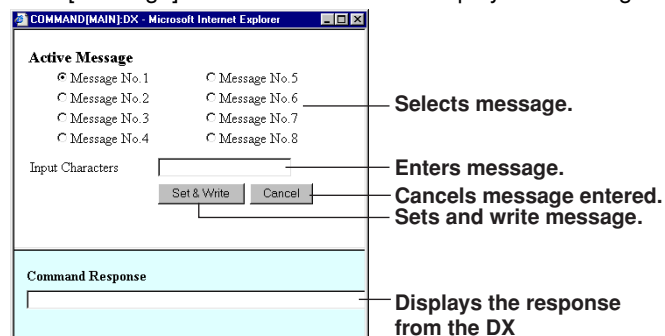

12. Click the message number button to select the message.
13. Enter the message string in the message box and click [Set & Write]. The message on the DX is set and the message appears on the trend display on the DX. The message is also written to the internal memory. To cancel the operation, click [Cancel].

Note

- The message is displayed on the trend display and written to the internal memory only when the data acquisition to the internal memory is in progress on the DX (The message is set regardless of whether or not the data acquisition to the internal memory is in progress).
- The response to the message setting and writing operations is displayed in the command response section.

Switching trend, digital, and bar graph displays

14. Click [Select group] of the trend, digital, or bar graph display in the display switch section to select the group. The DX screen changes to the specified display. The operator page is also refreshed.

**Operating using the DISP/ENTER key and arrow keys**

15. Click the [DISP/ENTER] key or arrow keys that are displayed on the operator page to operate the DX in the same fashion as the corresponding keys on the DX. The operator page is also refreshed.

2.11 Setting the E-Mail Transmission Function

Explanation

To use the e-mail transmission function, set the following parameters in addition to those described in section 2.3.

Basic settings of e-mail

- **SMTP* server name**
Set the SMTP server name (up to 64 alphanumeric characters) or the IP address of the SMTP server.
* Simple Mail Transfer Protocol
- **Port number**
Set the port number to use. The default value is 25.
- **Recipient 1**
Set the transmission destination of the e-mail message using up to 150 alphanumeric characters. You can specify multiple addresses. To specify multiple addresses, delimit the addresses using spaces.
- **Recipient 2**
Set the transmission destination of the e-mail message using up to 150 alphanumeric characters. You can specify multiple addresses. To specify multiple addresses, delimit the addresses using spaces.
- **Sender**
Set the e-mail address using up to 64 alphanumeric characters. If the address is not set, the first address set in the recipient box is used as the sender's address instead.

Settings for transmitting alarm information

- **Recipient 1, Recipient 2**
Turns On/Off for each recipient.
 - **On**
Transmits e-mail messages to the recipient.
 - **Off**
Does not transmit e-mail messages to the recipient.
- **Alarm number of which the alarm information is to be transmitted via the e-mail message (alarm 1, alarm 2, alarm 3, and alarm 4)**
You can turn On/Off the function for each alarm number. This setting is common to all channels.
 - **On**
If any one of the alarms corresponding to the relevant alarm number on all channels changes (alarm occurrence or release), an e-mail message is transmitted.
 - **Off**
The alarm information of the alarm number is not transmitted.
- **Contents of the transmitted mail**
 - **Add instantaneous values**
 - **On**
Adds to the e-mail message the instantaneous values of all channels existing at the time when the alarm condition changed.
 - **Off**
The instantaneous values are not added to the e-mail message.

- **Add sender URL (Uniform Resource Locator)**
 - **On**
If the Web server function is specified on the DX, the URL of the DX is attached to the e-mail.
 - **Off**
The URL of the DX is not attached to the e-mail.
- **Subject**
Set the subject of the e-mail message using up to 32 alphanumeric characters. The default value is "(DX)Alarm_summary."
- **Header1**
Set the string to be attached to the e-mail message using up to 64 alphanumeric characters.
- **Header2**
Set the string to be attached to the e-mail message using up to 64 alphanumeric characters.

Settings when transmitting e-mail messages at the specified time

- **Recipient 1, Recipient 2**
Turn On/Off for each recipient.
 - **On**
Transmits e-mail messages to the recipient.
 - **Off**
Does not transmit e-mail messages to the recipient.
- **Interval**
Time interval used to repeat the e-mail transmission starting from the Ref. Time. Select from the following list of choices for each recipient.
1h, 2h, 3h, 4h, 6h, 8h, 12h, and 24h
- **Ref. Time**
Specify the time when the e-mail message is transmitted in the following range for each recipient. The e-mail transmission is repeated every Interval from this point.
00:00 to 23:59
Example: If Ref. Time is 17:15 and Interval is 8h, e-mail messages are transmitted at 17:15, 01:15, and 09:15.
- **Contents of the transmitted mail**
See "Contents of the transmitted mail" on the previous page. The default value for [Subject] is "(DX)Periodic_data."

Settings when transmitting e-mail messages at the time of recovery from a power failure (System E-Mail settings).

For the transmitted contents of the system mail, see section 1.2.

- **Recipient 1, Recipient 2**
Turn On/Off for each recipient.
 - **On**
Transmits e-mail messages to the recipient.
 - **Off**
Does not transmit e-mail messages to the recipient.
- **Contents of the transmitted mail**
See "Contents of the transmitted mail" on the previous page. The instantaneous values of all channels are not to be added. The default value for [Subject] is "(DX)System_warning."

2.11 Setting the E-Mail Transmission Function

Settings when transmitting e-mail messages at the time of report creation (for models with the computation function /M1)

- **Recipient 1, Recipient 2**

Turn On/Off for each recipient.

- **On**

Transmits e-mail messages to the recipient.

- **Off**

Does not transmit e-mail messages to the recipient.

- **Contents of the transmitted mail**

See "Contents of the transmitted mail" on page 2-38. The instantaneous values of all channels are not to be added. The default value for [Subject] is "(DX)Report_data."

Saving the settings

To activate the settings that have been changed in the basic setting mode, the settings must be saved. Otherwise, the settings that existed before the change are activated.

Note

A character "o" that is set on the DX is displayed as a character "A" on the Web browser screen.

Procedure

For the basic flow of operations, see “Flow of Operation using the Operation Keys” on page vi. For the procedures related to entering character strings and values, see the DX100/DX200 User’s Manual (IM04L01A01-01E/IM04L02A01-01E).

1. Press the MENU key to display the setting menu.
2. Press the FUNC key for approximately 3 s to display the basic setting menu.
3. Press the [#11 (Web,E-Mail)](DX100) or [#7 (Web,E-Mail)](DX200) soft key to display the Web and e-mail setting menu.

Basic settings of e-mail

4. Press the [#2 (Basic E-Mail settings)] soft key to display the Web menu.

Basic E-Mail settings (DX100)
Basic E-Mail settings (DX200)

- **SMTP* server name**

5. Press the arrow key to move the cursor to the [SMTP server name] box.

6. Press the [Input] soft key to display the entry box.

7. In the box, enter the SMTP server name.

8. Press the DISP/ENTER key. The entered string/value is set in the [SMTP server name] box.

- **Port number**

9. Press the arrow key to move the cursor to the [Port number] box.

10. Press the [Input] soft key to display the entry box.

2.11 Setting the E-Mail Transmission Function

11. In the box, enter the port number.
12. Press the DISP/ENTER key. The entered string/value is set in the [Port number] box.

- **Recipient 1**

13. Press the arrow key to move the cursor to the [Recipient 1] box.

Port number	25
Recipient 1	
Recipient 2	

14. Press the [Input] soft key to display the entry box.

15. In the box, enter the address of the recipient 1.
16. Press the DISP/ENTER key. The entered string/value is set in the [Recipient 1] box.

- **Recipient 2**

17. Press the arrow key to move the cursor to the [Recipient 2] box.
18. Set the address of the recipient 2 using the same method as setting the address of the recipient 1.

- **Sender**

19. Press the arrow key to move the cursor to the [Sender] box.

Recipient 1	
Recipient 2	
Sender	

20. Press the [Input] soft key to display the entry box.

21. In the box, enter the address of the sender.
22. Press the DISP/ENTER key. The entered string/value is set in the [Sender] box.

Confirming/Canceling the new settings

23. To confirm the new settings, press the DISP/ENTER key. To cancel, press the ESC key.

For detailed operations regarding confirmation and cancellation, see "Flow of Operation using the Operation Keys" on page vi.

[Alarm E-Mail], [Scheduled E-Mail], [System E-Mail], [Report E-Mail]

24. Press the ESC key to display the Web, e-mail setting menu. Press the soft key to display the setting menu to be set.

[Alarm E-Mail]: Go to step 25.

[Scheduled E-Mail]: Go to step 42.

[System E-Mail]: Go to step 54.

[Report E-Mail]: Go to step 59.

- **[Alarm E-Mail settings]**

- **Recipient 1, Recipient 2**

25. Press the arrow key to move the cursor to the [Recipient 1] box or the [Recipient 2] box.

Alarm E-Mail settings	
E-Mail Recipients	
Recipient1	Off
Recipient2	Off

26. Press either the [On] or [Off] soft key.

On	Off
<input type="radio"/>	<input type="radio"/>

- **Alarm number of which the alarm information is to be transmitted via the e-mail message**

27. Press the arrow key to move the cursor to one of the [Alarm 1] through [Alarm 4] boxes.

Active alarms	
Alarm1	Off
Alarm2	Off
Alarm3	Off
Alarm4	Off

28. Press either the [On] or [Off] soft key.

On	Off
<input type="radio"/>	<input type="radio"/>

- **Add instantaneous values**

29. Press the arrow key to move the cursor to the [Include instantaneous value] (DX100) or [Include INST] (DX200) box.

E-Mail Contents	
Include INST	Off
Include source URL	Off
Subject	<DX> Alarm_summary
Header1	
Header2	

30. Press either the [On] or [Off] soft key.

On	Off
<input type="radio"/>	<input type="radio"/>

- **Add sender URL (Uniform Resource Locator)**

31. Press the arrow key to move the cursor to the [Include source URL] box.

Include source URL	Off
--------------------	-----

32. Press either the [On] or [Off] soft key.

On	Off
<input type="radio"/>	<input type="radio"/>

2.11 Setting the E-Mail Transmission Function

- **Subject**

33. Press the arrow key to move the cursor to the [Subject] box.



34. Press the [Input] soft key to display the entry box.



35. In the box, enter the subject.

36. Press the DISP/ENTER key. The entered string/value is set in the [Subject] box.

- **Header**

37. Press the arrow key to move the cursor to either the [Header 1] box or the [Header 2] box.



38. Press the [Input] soft key to display the entry box.



39. In the box, enter the character strings.

40. Press the DISP/ENTER key. The entered string/value is set in the [Header] box.

Confirming/Canceling the new settings

41. To confirm the new settings, press the DISP/ENTER key. To cancel, press the ESC key.

For detailed operations regarding confirmation and cancellation, see "Flow of Operation using the Operation Keys" on page vi.

- **[Scheduled E-Mail]**

- **Recipient 1, Recipient 2**

42. Set the address of the recipient 1 and 2 using the same method as steps 25 and 26.

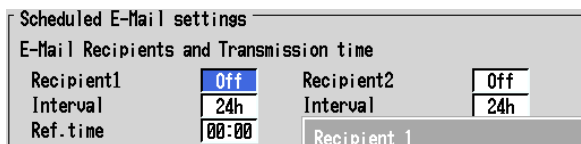

- **Interval**

43. Press the arrow key to move the cursor to the [Interval] box.



44. Press one of the soft keys from [1h] to [24h] to select the interval.

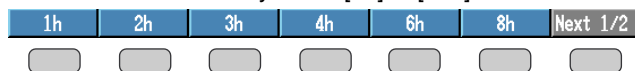

- **Ref. Time**

45. Press the arrow key to move the cursor to the [Ref. Time] box.

Recipient1	Off	Recipient2	Off
Interval	24h	Interval	24h
Ref.time	00:00	Ref.time	00:00

46. Press the [Input] soft key to display the entry box.



47. In the box, enter the reference time.
48. Press the DISP/ENTER key. The entered string/value is set in the [Ref. Time] box.

- **Add instantaneous values**

49. Set whether add or not the instantaneous values to the e-mail message using the same method as steps 29 and 30.

- **Add sender URL (Uniform Resource Locator)**

50. Set whether add or not the sender URL to the e-mail message using the same method as steps 31 and 32.

- **Subject**

51. Set the subject using the same method from steps 33 through 36.

- **Header**

52. Set the header using the same method from steps 37 through 40.

Confirming/Canceling the new settings

53. To confirm the new settings, press the DISP/ENTER key. To cancel, press the ESC key.
For detailed operations regarding confirmation and cancellation, see "Flow of Operation using the Operation Keys" on page vi.

- **[System E-Mail]**

- **Recipient 1, Recipient 2**

54. Set the address of the recipient 1 and 2 using the same method as steps 25 and 26.

- **Add sender URL (Uniform Resource Locator)**

55. Set whether add or not the sender URL to the e-mail message using the same method as steps 31 and 32.

- **Subject**

56. Set the subject using the same method from steps 33 through 36.

- **Header**

57. Set the header using the same method from steps 37 through 40.

2.11 Setting the E-Mail Transmission Function

Confirming/Canceling the new settings

58. To confirm the new settings, press the DISP/ENTER key. To cancel, press the ESC key.

For detailed operations regarding confirmation and cancellation, see "Flow of Operation using the Operation Keys" on page vi.

• [Report E-Mail]

• Recipient 1, Recipient 2

59. Set whether add or not the sender URL to the e-mail message using the same method as steps 31 and 32.

• Add sender URL (Uniform Resource Locator)

60. Set whether add or not the sender URL to the e-mail message using the same method as steps 31 and 32.

• Subject

61. Set the subject using the same method from steps 33 through 36.

• Header

62. Set the header using the same method from steps 37 through 40.

Confirming/Canceling the new settings

63. To confirm the new settings, press the DISP/ENTER key. To cancel, press the ESC key.

For detailed operations regarding confirmation and cancellation, see "Flow of Operation using the Operation Keys" on page vi.

Storing the new settings

64. Press the ESC key several times to display the basic setting menu.

65. Pressing the [End] soft key to display a dialog box which you select whether or not to store the new settings.



66. Select the [Yes] to store the new settings, the [No] to discard them, or the [Cancel] to return to the basic setting menu by pressing the arrow key. Then, press the DISP/ENTER key.

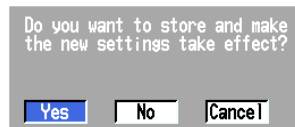

2.12 Performing an E-Mail Transmission Test

Explanation

You can transmit a test e-mail message to recipient 1 or recipient 2 that you specified in section 2.11 to confirm whether or not e-mail messages can be transmitted.

Items to check before performing this test

- Connect the Ethernet cable correctly. For the connection procedure, see section 2.2.
- Check that the Ethernet interface settings are correct. For the procedure, see section 2.3 or 2.5.
- Check that the e-mail settings are correct. For the procedure, see section 2.11.
When setting the Ethernet interface or e-mail, check the settings with your system or network administrator.

Checking the results of the e-mail transmission test

- The result of the e-mail transmission test can be confirmed by displaying the e-mail log (displayed on the DX (see section 2.8)) or Web browser screen (see section 2.10) or by outputting the result using the FL command (see section 5.8).
- If an error message is displayed on the DX, see appendix 5, "A List of Error Messages."

Contents of the test e-mail message

The figure below shows the contents of the test e-mail message.

```
From: DX@good.co.jp
Date: Sat, 23 Dec 2000 07:25:20 +0900 (JST)
Subject: (DX) Test_mail
To: user1@good.co.jp

Test mail.
<Host name>
DX

<Time>
Dec.23 07:25:20
```

Procedure

Performing e-mail transmission test

1. Press the FUNC key. The FUNC menu appears. The structure of the FUNC menu varies depending on the basic settings and options.
2. Press the E-Mail test soft key. A menu appears for you to select the recipient for the e-mail transmission test.



3. Press the Recipient 1 or Recipient 2 soft key. The e-mail transmission test is executed for the selected recipient.



2.13 Starting/Stopping E-Mail Transmissions

Explanation

Starting/Stopping e-mail transmissions

- If the e-mail transmission is started, the e-mail transmission function is activated.
- If the e-mail transmission is stopped, the e-mail transmission function is disabled.
The e-mail messages that have not been transmitted are cleared.

Note

- If the DX enters the basic setting mode while the e-mail transmission is started, the e-mail transmission is stopped. If the DX returns to the operation mode from the basic setting mode, the condition that existed before entering the basic setting mode is resumed.
- If a e-mail transmission fails, the DX retransmits the e-mail twice at intervals of 30 seconds. If all of the transmission fail, the mail is discarded.

Contents of the e-mail message

The figure below shows an example of an e-mail message.

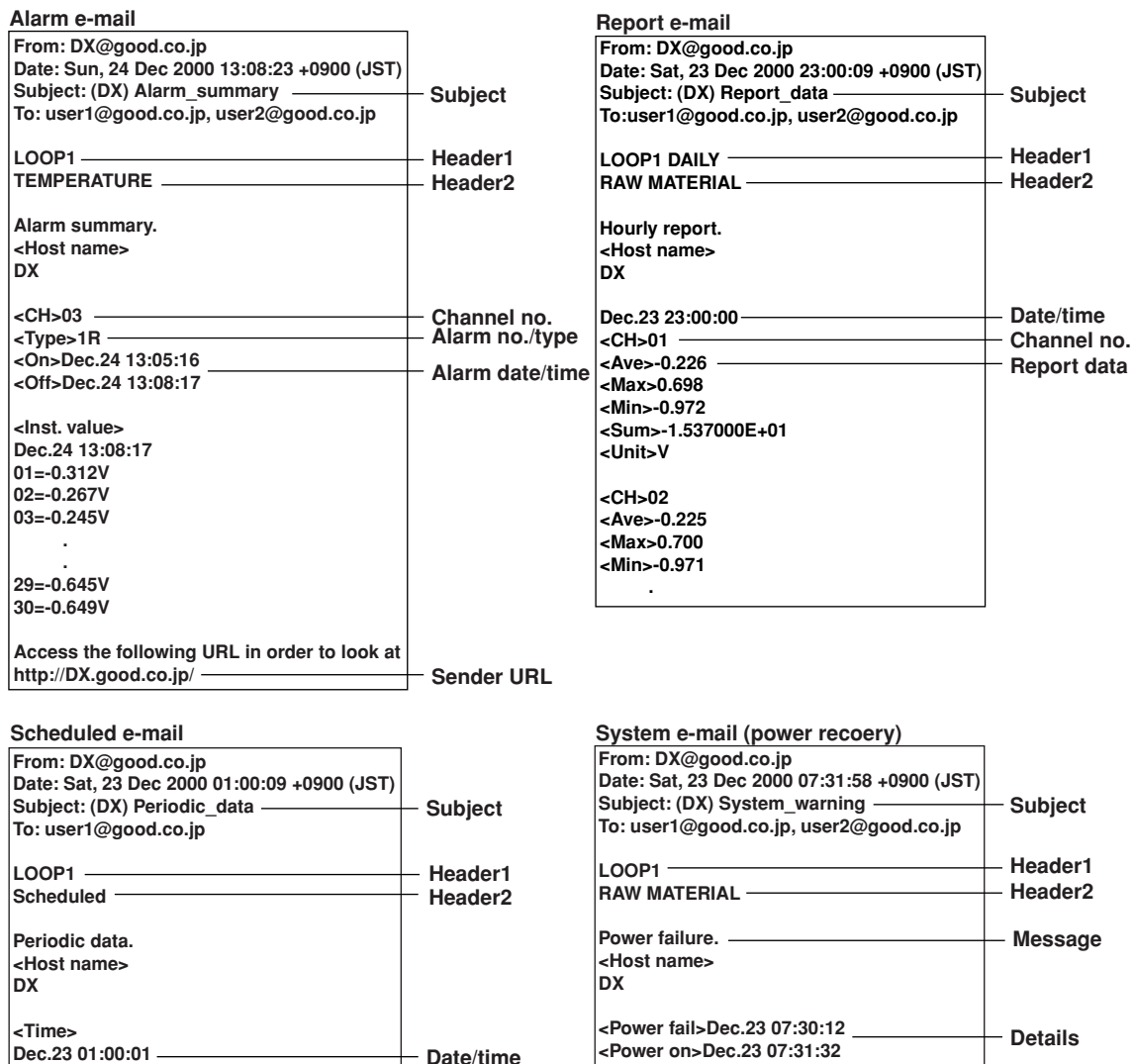

Procedure**Starting the e-mail transmission**

1. Press the FUNC key. The FUNC menu appears. The structure of the FUNC menu varies depending on the basic settings and options. If Next is displayed as a choice, this indicates that there are multiple lines of choices. Press the Next soft key to display the menu with the E-Mail start item.
2. Press the E-mail start soft key. E-mail transmission is started. An e-mail transmission function icon (✉) is displayed in the status display section of the DX.

**Stopping the e-mail transmission**

1. Press the FUNC key. The FUNC menu appears. The structure of the FUNC menu varies depending on the basic settings and options. If Next is displayed as a choice, this indicates that there are multiple lines of choices. Press the Next soft key to display the menu with the E-Mail stop item.
2. Press the E-mail stop soft key. E-mail transmission is stopped. The e-mail transmission function icon disappears from the status display section of the DX.

**Note**

The [E-Mail START] and [E-Mail STOP] soft keys are displayed on the FUNC key menu when the [Recipient1] or [Recipient2] for alarm, scheduled, system, or report e-mails is set to [ON].

3.1 Serial Interface (Option) Specifications

The specifications for the two types of serial interfaces (RS-232 and RS-422A/485) on the DX are given below.

RS-232 Interface Specifications

Connector type	D-Sub 9 pin plug
Electrical, mechanical specifications	Conforms to the EIA-574 standard (for the 9-pin interface of the EIA-232 (RS-232) standard)
Connection	Point-to-point
Communication	Half-duplex
Synchronization	Start-stop synchronization
Baud rate	Select from 1200, 2400, 4800, 9600, 19200, or 38400[bps]
Start bit	1 bit (fixed)
Data length (Select 8 bits when outputting data in binary format.)	Select 7 or 8 bits
Parity	Select odd, even, or none
Stop bit	1 bit (fixed)
Hardware handshaking	Select whether to fix the CA and CB signals to TRUE or to use the signal for flow control.
Software handshaking	Select whether to use the X-ON and X-OFF signals to control the transmitted data only or both the transmitted and received data. X-ON (ASCII 11H), X-OFF (ASCII 13H)
Received buffer size	2047 bytes

RS-422A/485 Interface Specifications

Terminal block type	6 point, terminal block, terminal screws: ISO M4/nominal length 6 mm		
Electrical, mechanical specifications	Conforms to EIA-422A (RS-422A) and EIA-485 (RS-485) standards		
Connection	Multidrop	Four-wire type	1 : 32
		Two-wire type	1 : 31
Communication	Half-duplex		
Synchronization	Start-stop synchronization		
Baud rate	Select from 1200, 2400, 4800, 9600, 19200, or 38400[bps]		
Start bit	1 bit (fixed)		
Data length	Select 7 or 8 bits		
Parity	Select odd, even, or none		
Stop bit	1 bit (fixed)		
Received buffer size	2047 bytes		
Escape sequence	Open and close		
Electric characteristics	FG, SG, SDB, SDA, RDB, RDA (six points) SG, SDB, SDA, RDB, and RDA terminals and the internal circuit of the DX is functionally isolated. FG terminal is the frame ground.		
Communication distance	Up to 1.2 km		
Terminator	External: recommended resistance 120 Ω , 1/2 W		

3.2 RS-232 Interface Connector Pin Arrangement and Signal Names, the Connection Procedure, and Handshaking

Connector Pin Arrangement and Signal Names

Connector pin arrangement

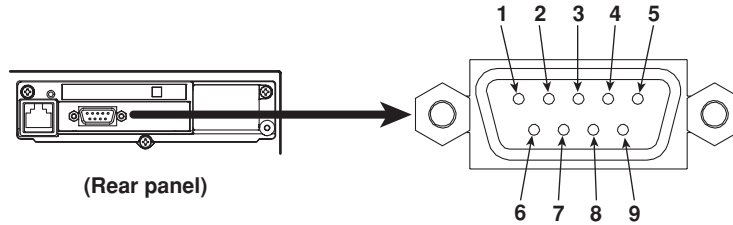

Pin No.	Signal Name	Signal Meaning
2	RD (Received Data)	Received data from the PC. Input signal.
3	SD (Send Data)	Send data to the PC. Output signal.
5	SG (Signal Ground)	Signal ground.
7	RS (Request to Send)	Handshaking signal used when receiving data from the PC. Output signal.
8	CS (Clear to Send)	Handshaking signal used when sending data to the PC. Input signal.

* Pins 1, 4, 6, and 9 are not used.

Table of RS-232 Standard Signal and Their JIS and ITU-T Abbreviations

Pin No. (9-pin connector)	Abbreviation			Description
	RS-232	ITU-T	JIS	
5	AB (GND)	102	SG	Signal ground
3	BA (TXD)	103	SD	Transmitted data
2	BB (RXD)	104	RD	Received data
7	CA (RTS)	105	RS	Request to send
8	CB (CTS)	106	CS	Clear to send

Connection Procedure

Signal direction

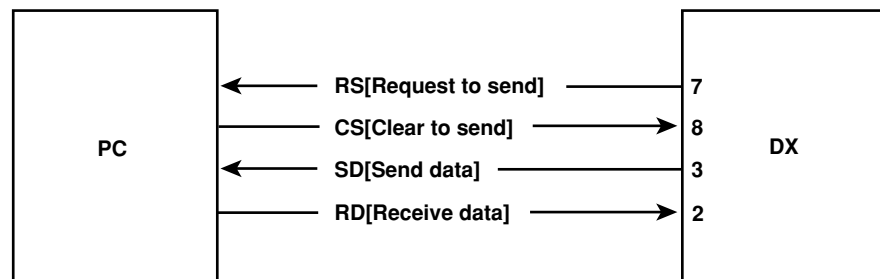

Connection example

• OFF-OFF/XON-XON

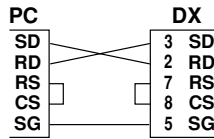

• CS-RS(CTS-RTS)

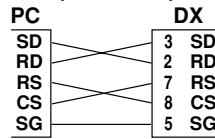

• XON-RS(XON-RTS)

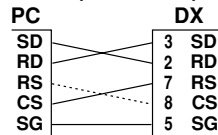

The RS on the PC side and the CS on the instrument side do not need to be connected for control. However, we recommend that they be connected so that the cable can be connected in either direction.

Handshaking

When using the RS-232 interface for transferring data, it is necessary for equipment on both sides to agree on a set of rules to ensure the proper transfer of data. The set of rules is called handshaking. Because there are many handshaking methods that can be used between the instrument and the PC, one must make sure that the same method is chosen by both the DX and the PC. You can choose any of the four methods shown in the following table.

Table of Handshaking Methods (○ indicates that it is supported)

Handshaking method	Data Transmission Control (Control used to send data to a PC)			Data Reception Control (Control used to receive data from a PC)		
	Software handshaking	Hardware handshaking	No handshaking	Software handshaking	Hardware handshaking	No handshaking
	Stops transmission when X-OFF is received. Resume when X-ON is received.	Stops transmission when CB (CTS) is false. Resume when it is true.		Send X-OFF when the received data buffer is 3/4th filled. Send X-ON when the received data buffer becomes 1/4th filled.	Set CA (RTS) to False when the received data buffer is 3/4th filled. Set to True when the received data buffer becomes 1/4th filled.	
OFF-OFF			○			○
XON-XON	○			○		
XON-RS	○				○	
CS-RS		○			○	

OFF-OFF

- Data transmission control
There is no handshaking between the DX and the PC. The X-OFF and X-ON signals are treated as data, and the CS signal is ignored.
- Data reception control
There is no handshaking between the DX and the PC. When the received buffer becomes full, all overflow data are discarded.
The RS signal is fixed to True.

3.2 RS-232 Interface Connector Pin Arrangement and Signal Names, the Connection Procedure, and Handshaking

XON-XON

- Data transmission control
Software handshaking is performed between the DX and the PC. When an X-OFF code is received while sending data to the PC, the DX stops the data transmission. When it receives the next X-ON code, it resumes the data transmission. The CS signal received from the PC is ignored.
- Data reception control
Software handshaking is performed between the DX and the PC. When the amount of used space in the received buffer reaches 1537 bytes, the X-OFF code is transmitted. When the amount of used space in the received buffer falls to 511 bytes, X-ON code is transmitted. The RS signal is fixed to True.

XON-RS

- Data transmission control
Software handshaking is performed between the DX and the PC. When an X-OFF code is received while sending data to the PC, the DX stops the data transmission. When it receives the next X-ON code, it resumes the data transmission. CS signal from the PC is ignored.
- Data reception control
Hardware handshaking is performed between the DX and the PC. When the amount of used space in the received buffer reaches 1537 bytes, the RS signal is set to "False." When the amount of used space in the received buffer falls to 511 bytes, the RS signal is set to "True."

CS-RS

- Data transmission control
Hardware handshaking is performed between the DX and the PC. When the CS signal becomes False while sending data to the PC, the DX stops the data transmission. When the CS signal becomes True, it resumes the data transmission. X-OFF is treated as data.
- Data reception control
Hardware handshaking is performed between the DX and the PC. When the amount of used space in the received buffer reaches 1537 bytes, the RS signal is set to "False." When the amount of used space in the received buffer falls to 511 bytes, the RS signal is set to "True."

Note

- The PC program must be designed so that the received buffers of both the DX and the PC do not become full.
- When using XON-XON, output the data in ASCII format.

3.3 RS-422A/485 Interface Pin Arrangement and Signal Names and the Connection Procedure

Pin Arrangement and Signal Names

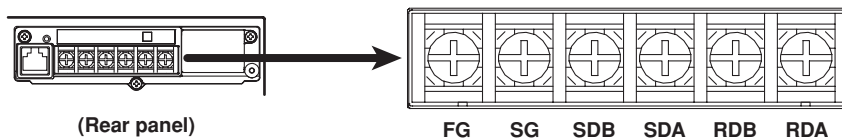

FG (Frame Ground)	Case ground of the DX.
SG (Signal Ground)	Signal ground.
SDB (Send Data B)	Send data B (+).
SDA (Send Data A)	Send data A (-).
RDB (Received Data B)	Received data B (+).
RDA (Received Data A)	Received data A (-).

Connection Procedure

Cable

There are two types of cables available, the four-wire cable and the two-wire cable (used only for the Modbus protocol). The cable should meet the following specifications.

Cable	Twisted-pair cable 3 pairs 24 AWG or more (four-wire), 2 pair 24AWG or more (two-wire)
Characteristic impedance	100 Ω
Capacitance	50 pF/m
Cable length	Up to 1.2 km*

* The transmission distance of the RS-422A/485 interface is not the straight-line distance, but rather the total length of the (twisted-pair shielded) cable.

Cable connection procedure

As shown in the figure below, attach a crimp-style terminal with an isolating sleeve for 4-mm screws to the end of the cable. Keep the section that is exposed from the shielded cable to 5 cm or less.

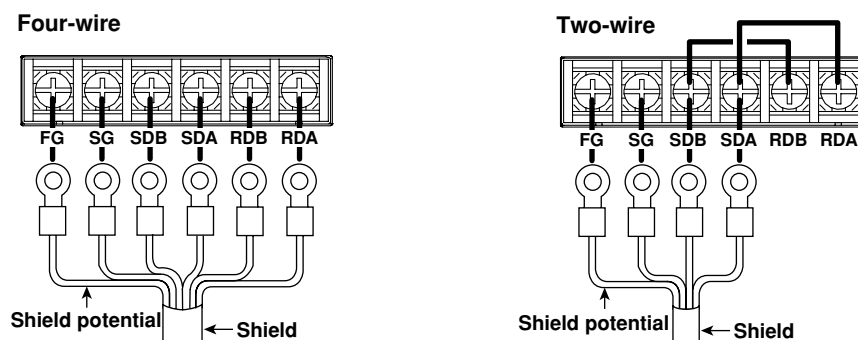

WARNING

To prevent electric shock, turn OFF the power when connecting cables.

Note

- As shown on the next page, connect the RD pin to the SD (TD) pin on the PC (converter) side and the SD pin to the RD pin on the PC side.
- The two-wire cable can be used only when using the Modbus protocol.

3.3 RS-422A/485 Interface Pin Arrangement and Signal Names and the Connection Procedure

Connection Example with the Host Computer

The instrument can be connected to a host computer that has an RS-232, RS-422A, or RS-485 port.

- For RS-232, use the converter.
- For recommended converters, see the latter section “Serial Interface converter.”
- The two-wire cable can be used only when using the Modbus protocol. For the configuration procedure, see section 3.5, “Configuring the Serial Interface.”

Four-wire system

In general, the instrument and the host computer are connected using a four-wire cable. For the four-wire system, the transmission and reception lines must be crossed.

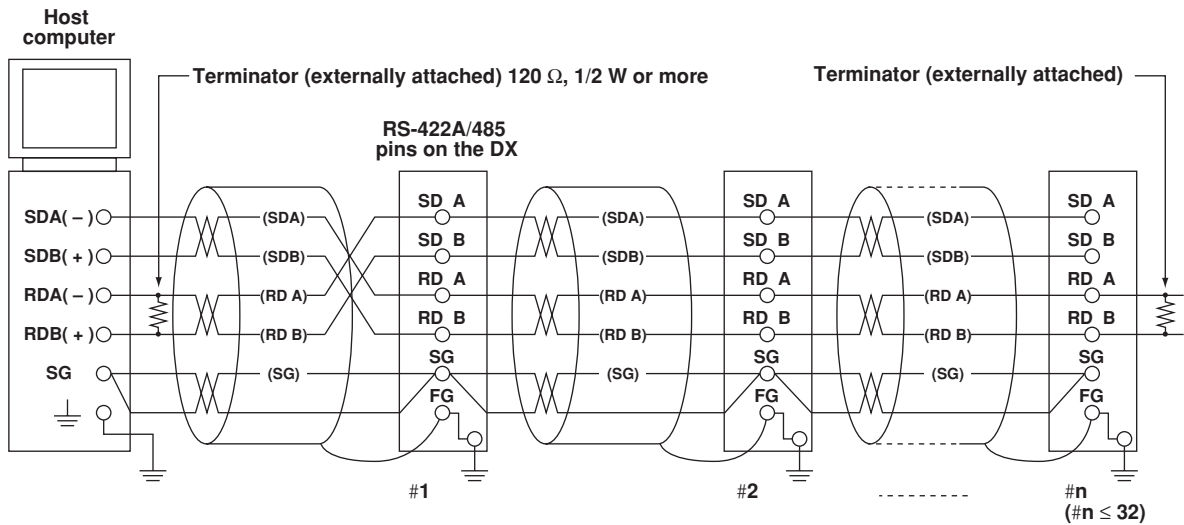

Do not connect terminator to #1 to #n-1

(The following diagram illustrates the case when the host computer's interface is RS-232)

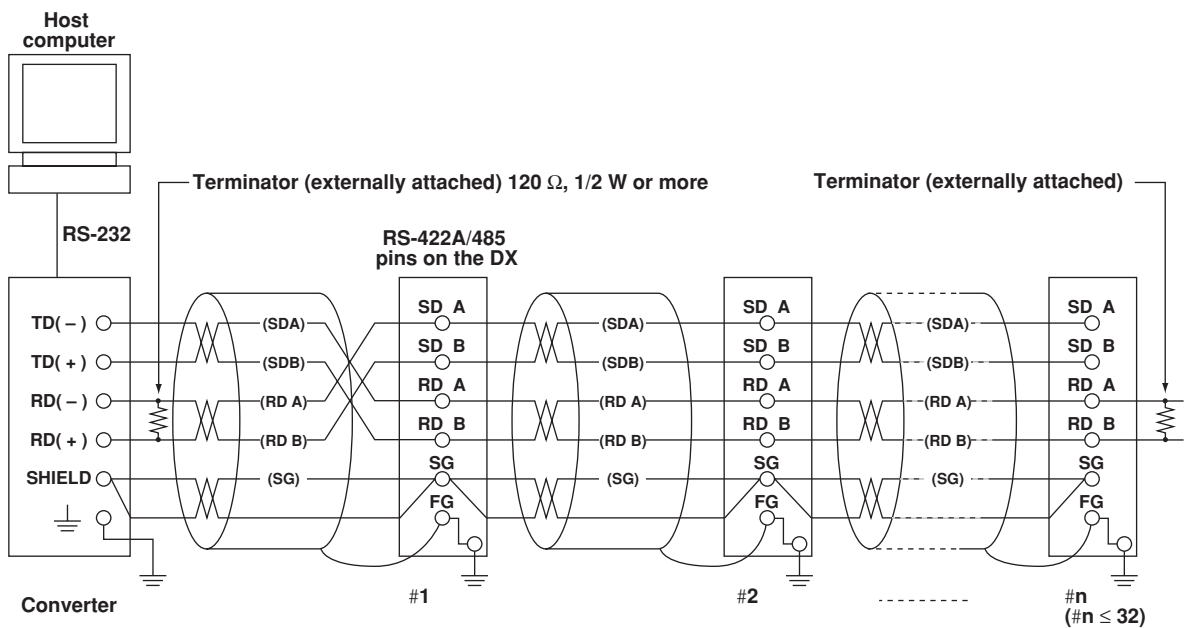

Do not connect terminator to #1 to #n-1

Two-wire system

Connect the transmission and reception signals with the same polarity on the RS-422A/485 terminal block. The two-wire system can be used only when using the Modbus protocol.

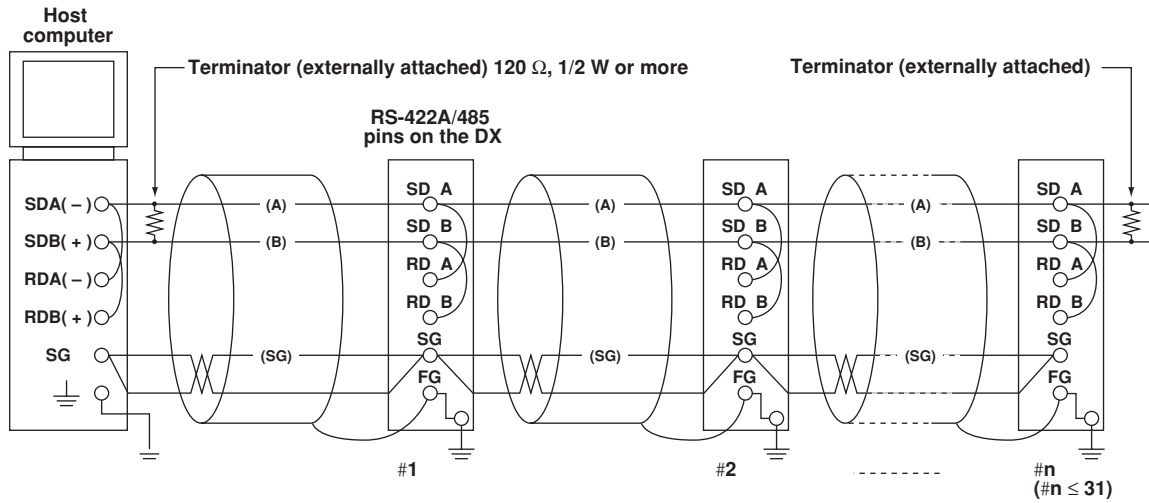

Do not connect terminator to #1 to #n-1

(The following diagram illustrates the case when the host computer's interface is RS-232)

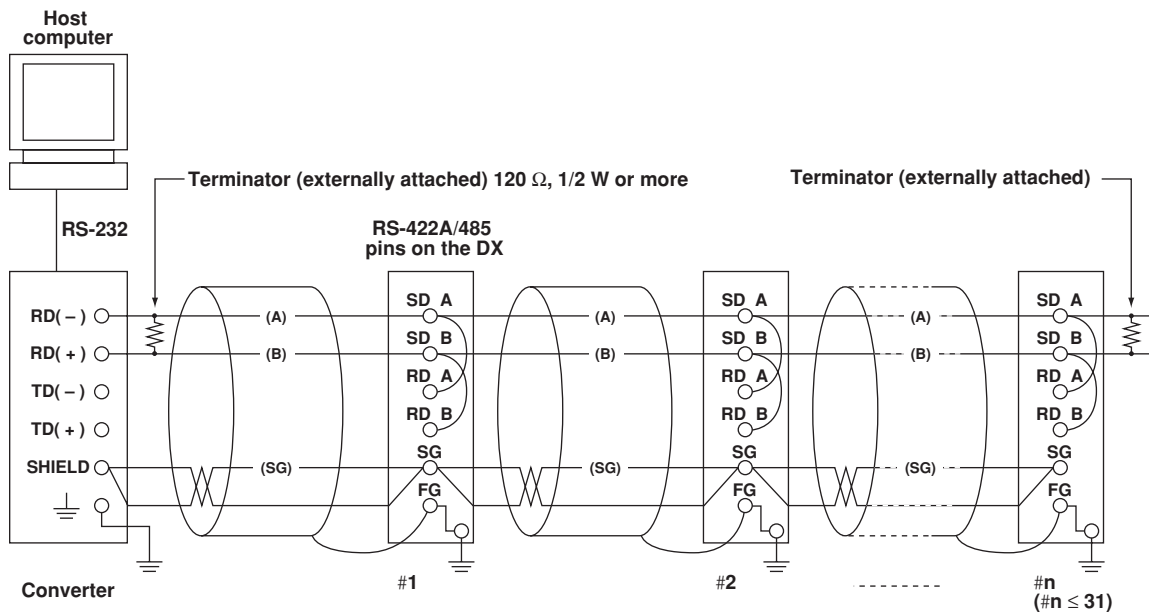

Do not connect terminator to #1 to #n-1

Note

- The method used to eliminate noise varies depending on the situation. In the connection example, only the cable shield on the DX side is connected to ground (one-sided grounding). This is effective when there is a difference in the electric potential between the PC's ground and the DX's ground. This may be the case for long distance communications. If there is no difference in the electric potential between the PC and the DX, two-sided grounding, in which the PC side is also grounded, may be effective. Furthermore, using two-sided grounding and connecting a serial capacitance on one-side may be effective. Consider these possibilities to eliminate noise.
- When using the two-wire type interface (Modbus protocol), the 485 driver must be set to high impedance within 3.5 characters after the last data byte is sent by the host computer.

Serial Interface Converter

Recommended converter: MODEL RC-57 by RA SYSTEMS CORP., or Z-101HE by Sharp



CAUTION

Some converters not recommended by Yokogawa have FG and SG pins that are not isolated. In this case, do not connect anything to the FG and SG pins as shown in the diagram on the previous page. This can generate a potential difference, especially for long distance communications, and can damage the instrument or cause communication abnormalities. For converters that do not have the SG pin, they can be used without using the signal ground. For details, see the manual that came with the converter.

On some non-recommended converters, the signal polarity may be reversed (A/B or +/- indication). In this case, reverse the connection.

For a two-wire system, the host computer must control the transmission driver of the converter in order to prevent collisions of transmit and received data. When using the recommended converter, the driver is controlled using the RS (RTS) signal on the RS-232.

When the instrument that support only the RS-422A interface exist in the system

When using the four-wire type interface, up to 32 DXs can be connected to a single host computer. However, this may not be true if the instrument that support only the RS-422A interface exist in the system.

When YOKOGAWA's recorders that support only the RS-422A interface exist in the system

The maximum number of connection is 16. Some of YOKOGAWA's conventional recorders (HR2400 and μ R, for example) only support the RS-422A driver. In this case, only up to 16 units can be connected.

Note

In the RS-422A standard, 10 is the maximum number of connections that are allowed on one port (for a four-wire system).

Terminator

When using a multidrop connection (including a point-to-point connection), connect a terminal resistance to the DX on the end of the chain. Do not connect a terminal resistance to a DX in the middle of the chain. In addition, turn the terminator on the host computer ON (see the computer's manual). If a converter is being used, turn ON its terminator. An external terminator must be attached to the recommended converter. However, there are converters that have built-in terminations.

3.4 The Bit Structure of One Character and the Operation of the Receive Buffer

The Bit Structure of One Character

The serial interface on the DX communicates using start-stop synchronization. With the start-stop synchronization, a start bit is added every time a character is transmitted. The start bit is followed by the data bits, parity bit, and stop bit. (See the figure below.)

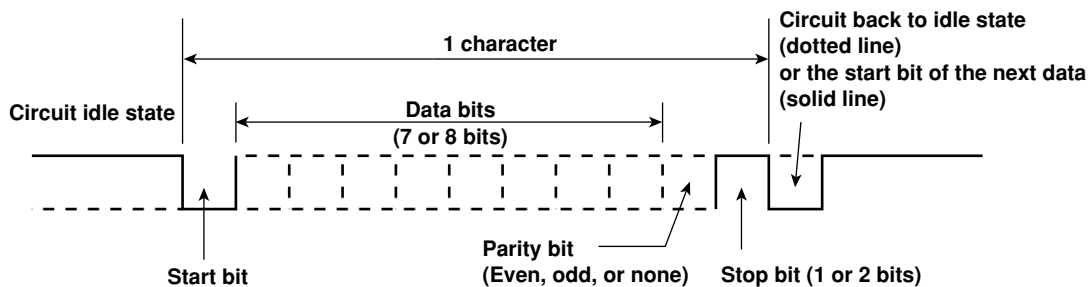

Receive Buffer and Received Data

The data received from the computer are first placed in the receive buffer of the DX. Depending on the available free space in the receive buffer, the received data are processed as shown in the figure below. When the receive buffer becomes FULL, overflow data are discarded.

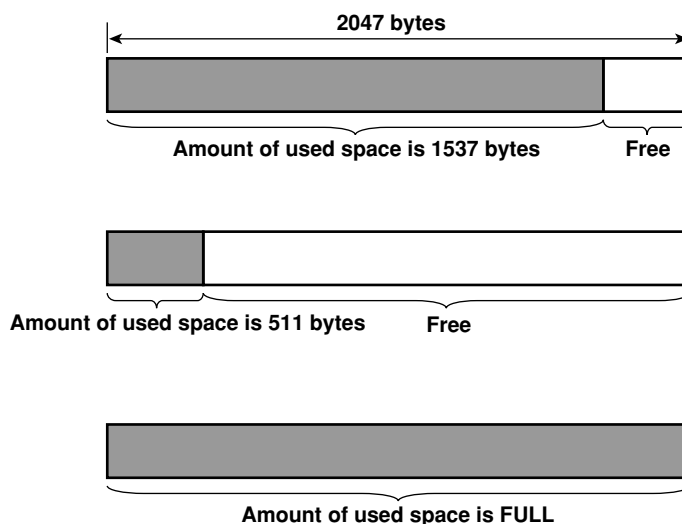

When handshaking is used, the DX stops data reception when data in the buffer cannot be processed fast enough and the amount of used space reaches 1537 bytes.

After the data reception is stopped as described above, data in the buffer continues to be passed to the internal program. When the amount of used space falls to 511 bytes, it resumes data reception.

If the buffer becomes full in spite of the handshaking control, all overflow data are discarded.

3.5 Configuring the Serial Interface

Explanation

Selecting the baud rate

Select the baud rate from the following list.

1200, 2400, 4800, 9600, 19200, 38400

Selecting the data length

Select the data length from the following list. Make sure to select 8 bits when outputting data in binary format.

7, 8

Selecting the parity check

Select the parity check from the following list.

Odd, Even, None

Selecting the handshaking method

Select the handshaking method from the following list. This setting is valid only for the RS-232 interface.

Off:Off, XON:XON, XON:RS, CS:RS

Selecting the address

Select the address from the following values. This setting is valid for the RS-422A/485 interface and the Modbus protocol.

1 to 32

Selecting the “Normal” protocol

When using the “Normal” protocol to communicate via RS-232 or RS-422A/485, select [Normal].

Selecting the communication interface used to output the data in the internal memory and the files on the external storage medium

- Using output commands (ME/MI/MO commands), select the communication interface used to output the data in the internal memory (display data, event data, TLOG data, manual sampled data, and report data) and the files on the external storage medium. Since Ethernet communications and serial communications cannot be used simultaneously, you must select either one.
- When using serial communications, select [Serial].

Storing the settings

To activate the settings made in the basic setting mode, the settings must be saved. Otherwise, the settings return to the previous values.

Procedure

For the basic flow of operations, see “Flow of Operation using the Operation Keys” on page vi.

1. Press the MENU key to display the setting menu.
2. Press the FUNC key for approximately 3 s to display the basic setting menu.
3. Press the [#10 (Communication)](DX100) or [#6 (Communication)](DX200) soft key to display the communication function setting menu.
4. Press the [#6 (Serial, Memory out)](DX100) or [#1 (Ethernet, Serial)](DX200) soft key to display the communication (Serial) menu.

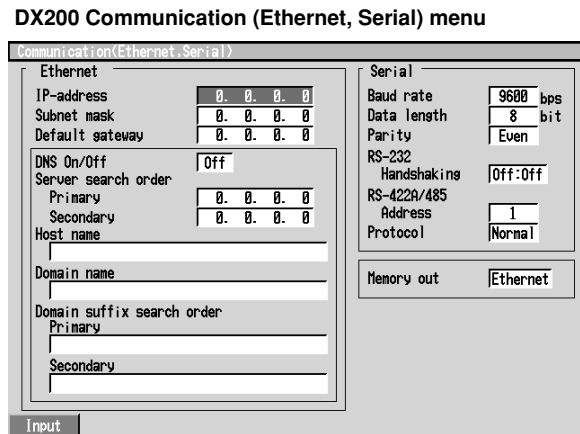
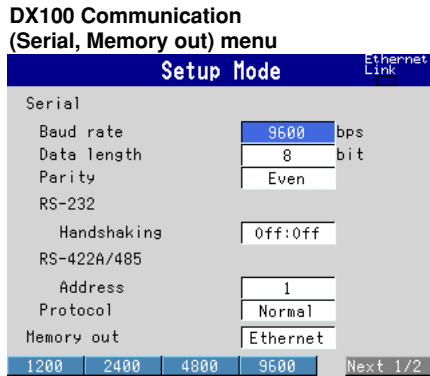

Selecting the baud rate

5. Press the arrow keys to move the cursor to the [Baud rate] box.

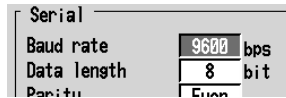

6. Press one of the soft keys from [1200] to [38400] to select the baud rate.



Selecting the data length

7. Press the arrow key to move the cursor to the [Data length] box.



8. Press the [7] or [8] soft key to select the data length.



3.5 Configuring the Serial Interface

Selecting the parity

9. Press the arrow keys to move the cursor to the [Parity] box.

Data length	8	bit
Parity	Even	

10. Press one of the soft keys from [Odd] to [None] to select the parity check.

Odd	Even	None
<input type="radio"/>	<input type="radio"/>	<input type="radio"/>

Selecting the handshaking

(Valid only for the RS-232 interface.)

11. Press the arrow keys to move the cursor to the [Handshaking] box.

Parity	Even
RS-232	
Handshaking	Off:Off

12. Press one of the soft keys from [Off:Off] to [CS:RS] to select the handshaking method.

Off:Off	XON:XON	XON:RS	CS:RS
<input type="radio"/>	<input type="radio"/>	<input type="radio"/>	<input type="radio"/>

Selecting the address

(Valid for the RS-422A/485 interface and the Modbus protocol)

13. Press the arrow keys to move the cursor to the [Address] box.

RS-422A/485	
Address	1
Protocol	Normal

14. Press one of the soft keys from [1] to [32] to select the address.

1	2	3	4	5	6	Next 1/6
<input type="radio"/>	<input type="radio"/>	<input type="radio"/>	<input type="radio"/>	<input type="radio"/>	<input type="radio"/>	<input type="radio"/>

Setting the protocol to “Normal”

15. Press the arrow keys to move the cursor to the [Protocol] box.

RS-422A/485	
Address	1
Protocol	Normal

16. Press the [Normal] soft key.

Normal	Modbus	Modbus-M
<input type="radio"/>	<input type="radio"/>	<input type="radio"/>

Selecting the communication interface used to output the data in the internal memory and the files on the external storage medium

17. Press the arrow key to move the cursor to the [Memory out] box.

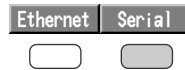

18. Press either the [Ethernet] or the [Serial] soft key. Press the [Serial] soft key when using serial communications.

**Confirming/Canceling the new settings**

19. To confirm the new settings, press the DISP/ENTER key. To cancel, press the ESC key.

For detailed operations regarding confirmation and cancellation, see "Flow of Operation using the Operation Keys" on page vi.

Storing the new settings

20. Press the ESC key several times to display the basic configuration menu.
 21. Press the [End] soft key to display a dialog box which you select whether or not to store the new settings.



22. Select the [Yes] to store the new settings, the [No] to discard them, or the [Cancel] to return to the basic setting menu by pressing the arrow key. Then, press the DISP/ENTER key

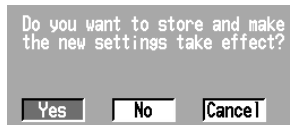

4.1 Modbus Protocol Specifications

The Modbus protocol can be used over the serial interface (RS-232 or RS-422A/485).

The Modbus specifications of the DX are as follows.

Specification	Description
Transmission medium	RS-232 or RS-422A/485
Control (Flow control is not available.)	RS-232: None only RS-422A/485: None only
Baud rate	Select from 1200, 2400, 4800, 9600, 19200, or 38400 [bps]
Start bit	1 bit (fixed)
Stop bit	1 bit (fixed)
Parity check	Odd, Even, None
Transfer mode	RTU (Remote Terminal Unit) mode only <ul style="list-style-type: none"> • Data length: 8 bits • Data interval: time equivalent to 24 bits or less* • Error detection: Uses CRC-16 <ul style="list-style-type: none"> * Time interval equivalent to 3.5 characters or more is used to detect the end of the message.
Slave address	RS-232: 1 to 32 RS-422A/485: 1 to 32

The function code of Modbus protocol that are supported by the DX are as follows.

Slave

The slave function of the DX does not support broadcast commands.

Function Code	Function	Operation
3	Reading the hold register (4xxxx).	The master device can read the communication input data of the DX that are written to the communication input data using function code 6 or 16.
4	Reading the input register (3xxxx).	The master device loads the computed, measured, and time data of the DX.
6	Writing to the hold register (4xxxx)	The master device writes to the communication input data of the DX.
8	Loopback test	Supports message return (test code (0x00*)) in response to a loopback test by the master device.
16	Writing to the hold register (4xxxx)	The master device writes to the communication input data of the DX.

* Hexadecimal "00"

Master

Function Code	Function	Operation
3	Reading the hold register (4xxxx, 4xxxxx).	The DX reads the hold register data of another device and make it the communication input data (Cxx).
4	Reading the input register (3xxxx, 3xxxxx).	The DX reads the input register data of another device and make it the communication input data (Cxx).

4.2 Register Assignments (Modbus Slave)

The register assignments of the Modbus protocol are given below. The data in the register do not contain unit and decimal position information. The unit and decimal position information must be set to the Modbus master (host) beforehand.

A binary value is put into the registers with the MSB (Most Significant Bit) first.

Input register	Data
30001	Measured data of CH01
:	:
30030	Measured data of CH30
	<ul style="list-style-type: none"> The corresponding registers: 30001 to 30002 on the DX102. 30001 to 30004 on the DX104. 30001 to 30006 on the DX106. 30001 to 30012 on the DX112. 30001 to 30004 on the DX204. 30001 to 30008 on the DX208. 30001 to 30010 on the DX210. 30001 to 30020 on the DX220. 30001 to 30030 on the DX230. Measured data is a "16-bit signed integer." Values are the same as the measured data in binary format (see section 6.3).
31001	Alarm status of the measured data of CH01
:	:
31030	Alarm status of the measured data of CH30
	<ul style="list-style-type: none"> The corresponding registers: 31001 to 31002 on the DX102. 31001 to 31004 on the DX104. 31001 to 31006 on the DX106. 31001 to 31012 on the DX112. 31001 to 31004 on the DX204. 31001 to 31008 on the DX208. 31001 to 31010 on the DX210. 31001 to 31020 on the DX220. 31001 to 31030 on the DX230. Alarm status is a "16-bit unsigned integer." Values are the same as the alarm status in binary format.(see section 6.3). The register holds the data in the order as A2A1A4A3.
32001	Computed data of CH31 (upper byte)
32002	Computed data of CH31 (lower byte)
32003	Computed data of CH32 (upper byte)
:	:
32060	Computed data of CH60 (lower byte)
	<ul style="list-style-type: none"> The corresponding registers: 32001 to 32016 on the DX102/DX104/DX204/DX208. 32001 to 32024 on the DX106/DX112.. 32001 to 32060 on the DX210/DX220/DX230. These registers are for models with the computation function option /M1. Computed data is a "32-bit signed integer." Two registers are assigned per a computed data. Values are the same as the computed data in binary format (see section 6.3).
33001	Alarm status of the Computed data of CH31
:	:
33030	Alarm status of the Computed data of CH60
	<ul style="list-style-type: none"> The corresponding registers: 33001 to 33008 on the DX102/DX104/DX204/DX208. 33001 to 33012 on the DX106/DX112. 33001 to 33030 on the DX210/DX220/DX230. These registers are for models with the computation function option /M1. Alarm status is a "16-bit unsigned integer." Values are the same as the alarm status in binary format (see section 6.3). The register holds the data in the order as A2A1A4A3.
39001	Year (4 digits)
39002	Month
39003	Day
39004	Hour
39005	Minute
39006	Second
39007	Millisecond
39008	Summer/Winter time

Hold register	Data
40001	Communication input data of C01
:	:
40030	Communication input data of C30
	A value in the range from -32768 to 32767 can be written in the hold register. For DX100, the hold register is from 40001 to 40012 (from C01 to C12.)

4.3 Modbus Error Response (Modbus Slave)

When using the Modbus slave function, the DX returns the error codes below to the master device. For the error messages related to communications that the DX displays, see appendix 6.

Code	Meaning	Cause
1	Bad function code	Requested a function that is not supported. For supported functions, see section 4.1, "Modbus Protocol Specifications."
2	Bad register number	Tried to read/write to a register that has no corresponding channel.
3	Bad number of registers	The number of specified registers is zero.
7	Cannot be executed.	Tried to read a computation register from a model that has no computation option.

However, no response is returned for the following cases.

- CRC error
- Errors other than the ones shown above.

4.4 Setting the Configuration that is Used When the Modbus Protocol is Used

Explanation

Selecting the baud rate

Select the baud rate from the following list.
1200, 2400, 4800, 9600, 19200, 38400

Selecting the parity check

Select the parity check from the following list.
Odd, Even, None

Selecting the slave address (valid when Modbus slave function is engaged)

Select the address from the following values.
1 to 32

Selecting the “Modbus” protocol

When communicating using the “Modbus” protocol, select [Modbus].

Selecting the communication interface used to output the data in the internal memory and the files on the external storage medium

Select [Ethernet], if you use output commands (ME/MI/MO commands) to output the data in the internal memory (display data, event data, TLOG data, manual sampled data, and report data) and the files on the external storage medium. Selecting [Serial] has no effect.

Storing the settings

To activate the settings made in the basic setting mode, the settings must be saved. Otherwise, the settings return to the previous values.

Note

When using the Modbus protocol, setting the data length and handshaking produces no effect.

Procedure

For the basic flow of operations, see “Flow of Operation using the Operation Keys” on page vi.

1. Press the MENU key to display the setting menu.
2. Press the FUNC key for approximately 3 s to display the basic setting menu.
3. Press the [#10 (Communication)](DX100) or [#6 (Communication)](DX200) soft key to display the communication function setting menu.
4. Press the [#6 (Serial, Memory out)](DX100) or [#1 (Ethernet, Serial)](DX200) soft key to display the communication (Serial) menu.

DX100 Communication (Serial, Memory out) menu

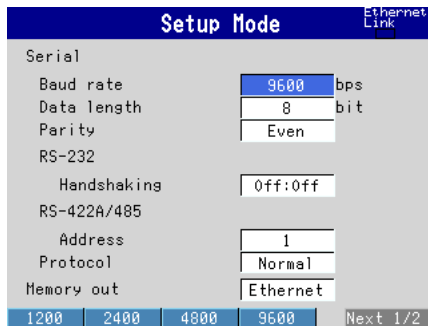

DX200 Communication (Ethernet, Serial) menu

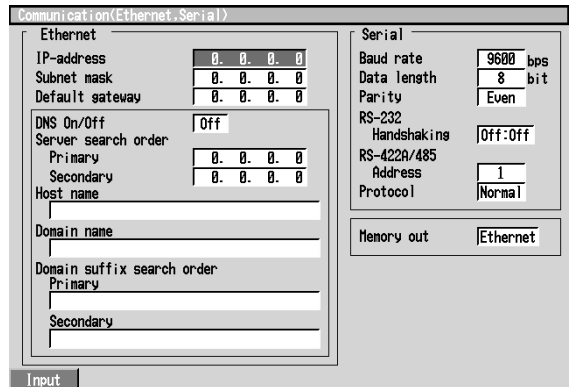

Selecting the baud rate

5. Press the arrow keys to move the cursor to the [Baud rate] box.



6. Press one of the soft keys from [1200] to [38400] to select the baud rate.



Selecting the parity check

7. Press the arrow keys to move the cursor to the [Parity] box.



8. Press one of the soft keys from [Odd] to [None] to select the parity check.



4.4 Setting the Configuration that is Used When the Modbus Protocol is Used

Selecting the slave address (valid when Modbus slave function is engaged)

9. Press the arrow keys to move the cursor to the [Address] box.



RS-422A/485	
Address	1
Protocol	Normal

10. Press one of the soft keys from [1] to [32] to select the address.



1	2	3	4	5	6	Next 1/6
<input type="radio"/>	<input type="radio"/>	<input type="radio"/>	<input type="radio"/>	<input type="radio"/>	<input type="radio"/>	<input type="radio"/>

Setting the protocol to “Modbus”

11. Press the arrow keys to move the cursor to the [Protocol] box.



RS-422A/485	
Address	1
Protocol	Normal

12. Press the [Modbus] soft key when using the Modbus slave function.
Press the [Modbus-M] soft key when using the Modbus master function.

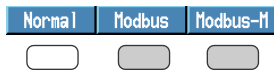

Normal	Modbus	Modbus-M
<input type="radio"/>	<input type="radio"/>	<input type="radio"/>

Selecting the communication interface used to output the data in the internal memory and the files on the external storage medium

13. Press the arrow key to move the cursor to the [Memory out] box.



Memory out	Ethernet
------------	----------

14. Press the [Ethernet] soft key when transferring data via Ethernet. Pressing the [Serial] soft key has no effect.



Ethernet	Serial
<input type="radio"/>	<input type="radio"/>

Confirming/Canceling the new settings

15. To confirm the new settings, press the DISP/ENTER key. To cancel, press the ESC key.

For detailed operations regarding confirmation and cancellation, see “Flow of Operation using the Operation Keys” on page vi.

Storing the new settings

16. Press the ESC key several times to display the basic setting menu.
17. Pressing the [End] soft key to display a dialog box which you select whether or not to store the new settings.



End
<input type="radio"/>

18. Select the [Yes] to store the new settings, the [No] to discard them, or the [Cancel] to return to the basic setting menu by pressing the arrow key. Then, press the DISP/ENTER key.

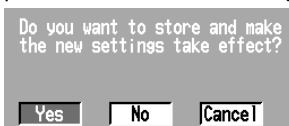

Do you want to store and make the new settings take effect?		
Yes	No	Cancel

4.5 Setting the Modbus Master Function

Explanation

Selecting the read cycle

The cycle at which data is read from other devices. Select the read cycle from the following:

125 ms, 250 ms, 500 ms, 1 s, 5 s, 2 s, 10 s

Selecting the timeout time

If there is no response from the specified slave device after transmitting a command from the DX over the time specified here (timeout time), the DX repeats the operation of sending the command the specified number of retrials (see below) and waiting. If there is no response from the slave device after the specified number of retrials, the DX stops sending commands to the slave device.

Operation when there is no response from the slave device (the number of retrials is set to 2)

- ↓ : Commands are sent to the slave device at the read cycle.
- : The slave device responds.
- X : The slave device does not respond.

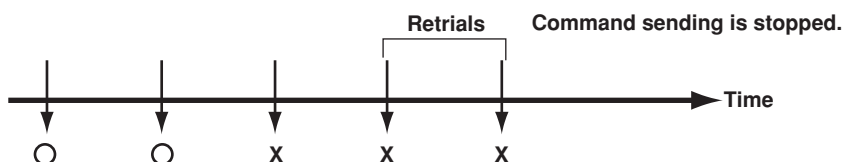
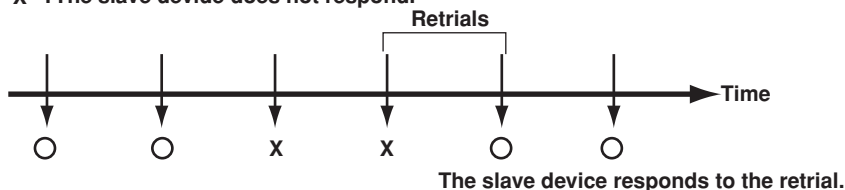

Select the timeout time from the following:

125 ms, 250 ms, 500 ms, 1 s, 5 s, 2 s, 10 s, and 1 min

Selecting the number of retrials

The number of times to retransmit the command when there is no response from the specified slave device. If there is no response from the slave device after the specified number of retrials, the DX stops sending commands to the slave device. Select the number of retrials from the following:

Off (0), 1, 2, 3, 4, 5, 10 and 20

Setting the command

The commands are used to read data from slave devices at the read cycle, and put them to the communication input data of the DX. Data from the consecutive registers with the same type of data in a slave device, can be read and put to the consecutive communication input data of the DX using a command.

- **Turning On/Off the command**

Turn On the command registration line to be used. Up to eight commands can be registered.

4.5 Setting the Modbus Master Function

- **Read channel (start CH, end CH)**

Specify which communication input data will be assigned the data that is read from the slave device (DX100: C01 to C12, DX200: C01 to C30).

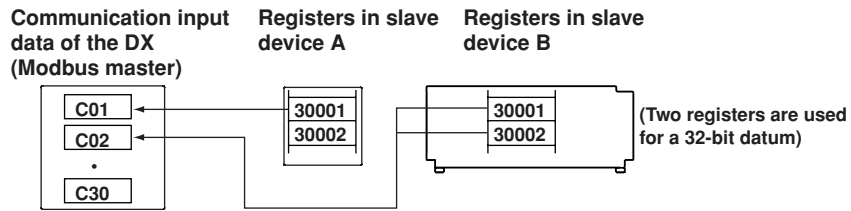

- **Address**

Specify the address of the slave device from the following:
1 to 247

- **Register**

Specify the register number of the slave device. 32-bit data is assigned to two registers. Thus, specify the smaller register number (see "Type" below).

Input register: 30001 to 39999, 300001 to 365535

Hold register: 40001 to 49999, 400001 to 465535

- **Type**

Specify the type of data that is assigned to the Modbus register of the slave device (the DX reads all data as floating point data).

- **INT16**

Specify this parameter when a "16-bit signed integer" is assigned to the Modbus register.

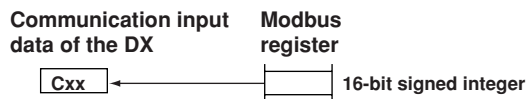

- **UINT16**

Specify this parameter when a "16-bit unsigned integer" is assigned to the Modbus register.

- **INT32_B**

Specify this parameter when a "32-bit signed integer" is assigned to the Modbus register in the order upper 16 bits followed by the lower 16 bits.

Specify the smaller register number (the higher register number in this case) in Register.

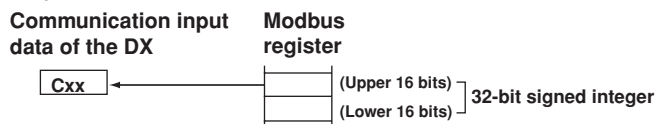

- **INT32_L**

Specify this parameter when a "32-bit signed integer" is assigned to the Modbus register in the order lower 16 bits followed by the upper 16 bits.

Specify the smaller register number (the lower register number in this case) in Register.

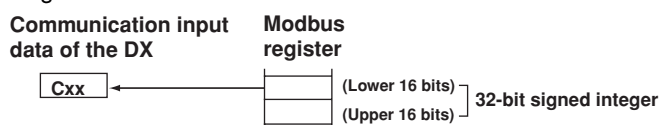

- **UINT32_B**
Specify this parameter when a “32-bit unsigned integer” is assigned to the Modbus register in the order upper 16 bits followed by the lower 16 bits.
Specify the smaller register number (the higher register number in this case) in Register.
- **UINT32_L**
Specify this parameter when a “32-bit unsigned integer” is assigned to the Modbus register in the order lower 16 bits followed by the upper 16 bits.
Specify the smaller register number (the lower register number in this case) in Register.
- **FLOAT_B**
Specify this parameter when a “32-bit floating-point data” is assigned to the Modbus register in the order upper 16 bits followed by the lower 16 bits.
Specify the smaller register number (the higher register number in this case) in Register.
- **FLOAT_L**
Specify this parameter when a “32-bit floating-point data” is assigned to the Modbus register in the order lower 16 bits followed by the upper 16 bits.
Specify the smaller register number (the lower register number in this case) in Register.

Setting Example

If you set as shown in the figure below, the DX reads an “INT16” value from register 30001 to put it to C01, and an “INT16” value from register 30002 to C02.

	On	Comm. Data		Address	Slave Registers	
		First	Last		Address	Type
1	On	C01	/ C02	1	30001	INT16

Displaying the read data

The data that is read can be displayed by writing a computing equation using C01 through C30 (C01 to C12 for DX100) on a computation channel (/M1 option). The decimal position and the unit are specified by the slave device. Convert the read value to a value with an appropriate unit using the computation equation (see an example below). For information on the use of the computation channel, see the DX100/DX200 User’s Manual (IM04L01A01-01E/IM04L02A01-01E).

Example

Assigns the communication input data C01 to the computation channel 31.

Read an “INT16” value from register 30001 of the slave device with the address “1,” to put it to the communication input data C01 of the DX. Change the value to have two digits of decimal fraction (multiply 0.01) and a unit “V.”

- **Command**
First communication data: 01, Address: 1, Register: 30001, Type: INT16
- **Computation channel**
Computation equation for Channel 31: C01*K01
Unit: V
Constant: K01=0.01

4.5 Setting the Modbus Master Function

Procedure

For the basic flow of operations, see “Flow of Operation using the Operation Keys” on page vi. For the procedures related to entering character strings and values, see the DX100/DX200 User’s Manual (IM04L01A01-01E/IM04L02A01-01E).

1. Press the MENU key to display the setting menu.
2. Press the FUNC key for approximately 3 s to display the basic setting menu.
3. Press the [#10 (Communication)](DX100) or [#6 (Communication)](DX200) soft key to display the communication function setting menu.
4. Press the [#7 (Modbus master (BASIC)))] or [#4 (Modbus Master)]soft key to display the Modbus master (BASIC) menu.

DX100 Modbus master (BASIC) menu

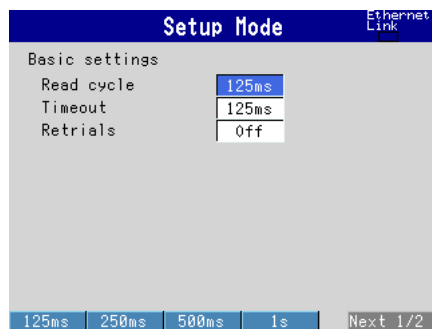

DX200 Modbus master menu

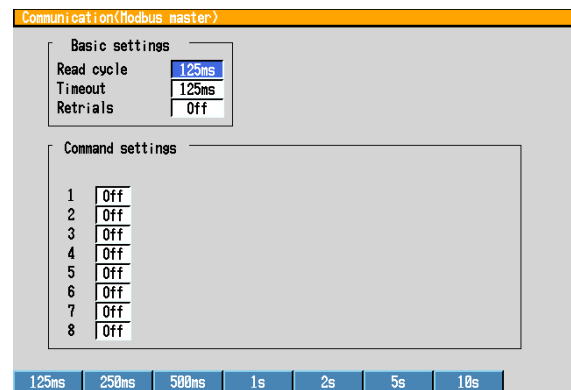

Selecting the read cycle

5. Press the arrow keys to move the cursor to the [Read cycle] box.

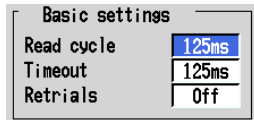

6. Press one of the soft keys from [125ms] to [10s] to select the read cycle.

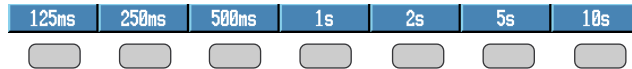

Selecting the timeout time

7. Press the arrow keys to move the cursor to the [Time out] box.

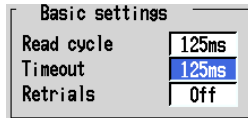

8. Press one of the soft keys from [125ms] to [1min] to select the timeout time.



Selecting the number of retries

9. Press the arrow keys to move the cursor to the [Retrials] box.

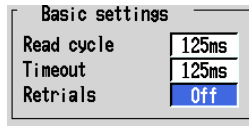

10. Press one of the soft keys from [Off] to [20] to select the address.



For DX100, confirm the new settings pressing the DISP/ENTER key. To cancel, press the ESC key.

For detailed operations regarding confirmation and cancellation, see “Flow of Operation using the Operation Keys” on page vi.

Setting the command

For DX100, when settings are confirmed by procedure 10, press the ESC key to return to the communication function setting menu, and then press the [#8 (Modbus master (COMMAND))] soft key to display the command setting menu.

11. Press the arrow keys to move the cursor to the [On/Off] box.

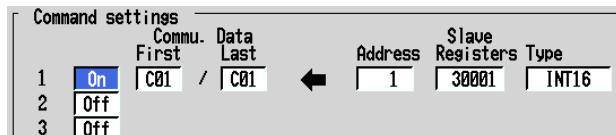

12. Press either the [On] or [Off] soft key. If you select [On], go to step 13. If you select [Off], go to step 24.

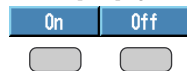

Communication input data (First, Last)

13. Press the arrow key to move the cursor to the [First channel] box.



14. Press one of the soft keys from [C01] to [C12] (DX100) or [C01] to [C30] (DX200) to select the first communication input data.

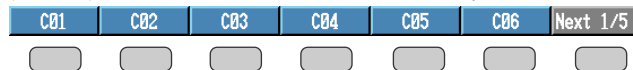

15. Set the last communication input data using the same method as steps 13 and 14.



Slave address

16. Press the arrow key to move the cursor to the [Address] box.



4.5 Setting the Modbus Master Function

- Press the [Input] soft key to display the entry box.



- Enter the slave address in the entry box.

• Register

- Press the arrow key to move the cursor to the [Register] box.



- Press the [Input] soft key to display the entry box.



- Enter the slave address in the entry box

• Type

- Press the arrow key to move the cursor to the [Type] box.



- Press one of the soft keys from [INT16] to [FLOAT_L] to select the register type.



Confirming/Canceling the new settings

- To confirm the new settings, press the DISP/ENTER key. To cancel, press the ESC key.

For detailed operations regarding confirmation and cancellation, see “Flow of Operation using the Operation Keys” on page vi.

Storing the new settings

- Press the ESC key several times to display the basic setting menu.

- Pressing the [End] soft key to display a dialog box which you select whether or not to store the new settings.



- Select the [Yes] to store the new settings, the [No] to discard them, or the [Cancel] to return to the basic setting menu by pressing the arrow key. Then, press the DISP/ENTER key.

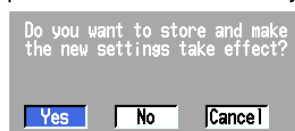

4.6 Checking the Operating Status of the Modbus Master Function

Explanation

MODBUS STATUS screen

You can check the operating status of the Modbus master function on the MODBUS STATUS screen.

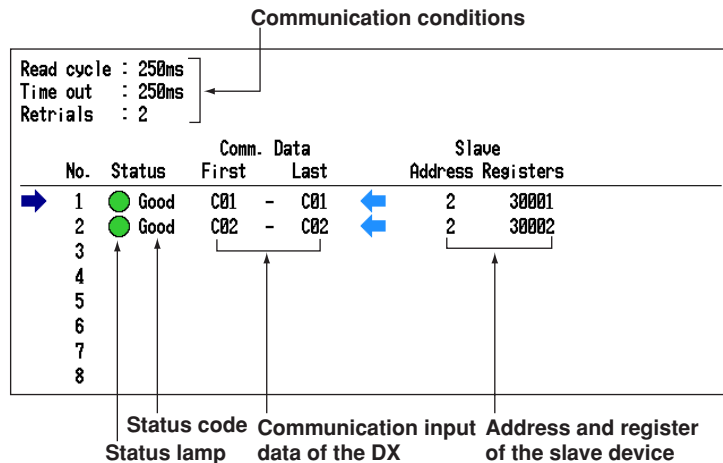

Communication condition

The communication status is displayed through the status lamp and the detail code.

Status Lamp	Detail Code	Meaning
Green	GOOD	Communication is operating normally.
Yellow		Retrying.
Red		Communication is suspended as it is not recovered after the specified number of retrials.
	NONE	No response from the slave device.
	FUNC	The slave device cannot execute the command from the DX.
	REGI	The slave device does not have the specified register.
	ERR	There is an error in the response data from the slave device.
	(Space)	The detail code is not displayed until the status is confirmed when communication is started.

Resuming command transmission

Through key operation, you can resume command transmission to the slave device to which the command transmission is stopped (indicated by a red status lamp).

Data while retrying/when command transmission is stopped

While retrying, the communication input data (Cxx) is held at the latest value. When command transmission is stopped, the communication input data turns to be an error data. In this case, computation channels display "+*****x."

Data dropout

Data dropout occurs when commands 1 through 8 cannot be completed in a read cycle. The communication input data (Cxx) is held at the previous value. Take measures such as making the read cycle longer or reducing the number of commands.

4.6 Checking the Operating Status of the Modbus Master Function

Procedure

Displaying the MODBUS STATUS screen

1. Press the FUNC key. The FUNC menu appears. The structure of the FUNC menu varies depending on the basic settings and options.



2. Press the [Modbus master] soft key. The Modbus status screen appears.

Data dropout

When a data dropout occurs, the message “Data dropout” is displayed on the MODBUS STATUS screen.



Press the right arrow key to clear the message.

Resuming command transmission to the slave device to which command transmission is stopped due to timeout

1. Using the up and down arrow keys, select the command corresponding to the slave device to which transmission will be resumed.

No.	Status	Comm. Data		Slave	
		First	Last	Address	Registers
1	● Good	C01	- C01	←	2 30001
2	● Good	C02	- C02	←	2 30002
3	● None	C03	- C03	←	3 30001
4					
5					

A message “Push [right arrow] key to refresh” appears.



2. Press the right arrow key to start command transmission to the specified slave device.

5.1 Command Syntax

Command Syntax

The syntax of the setting/basic setting/output commands (see sections 5.4 to 5.9) of the instrument is given below. ASCII codes are used for the character codes. For the syntax of the maintenance/test commands (see section 5.10) and instrument information output commands (see section 5.11), see the corresponding sections or the examples for each command.

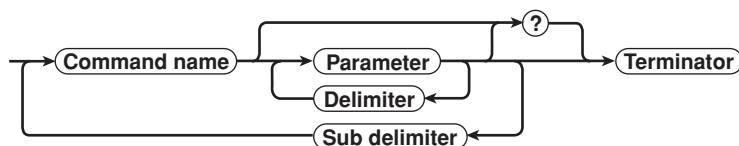

Command example

SR 02,SKIP;SR 03,VOLT,2V,-1500,1800

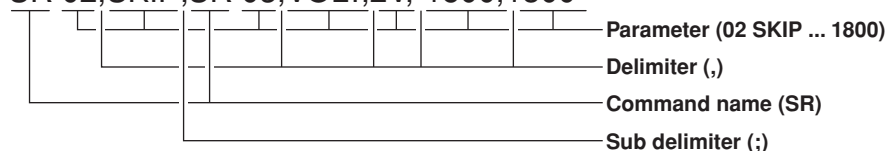

Command name

Defined using two alphabet characters.

Parameter

- Command parameters.
- Set using alphabet characters or numerical values.
- Parameters are separated by delimiters.
- All numerical values are specified using integers.
- When the parameter is a numerical value, the valid range varies depending on the command.
- Spaces before and after of the parameter are ignored (except for parameters that are specified using an ASCII character string (unit), when spaces are valid.)
- You can omit the parameters that do not need to be changed from their current settings. However, delimiters cannot be omitted.

Example SR 01, ,2V<terminator>

If multiple parameters are omitted and delimiters occur at the end of the command, those delimiters can be omitted.

Example SR 01,VOLT, , ,<terminator> → SR 01,VOLT<terminator>

- The number of digits of the following parameters is fixed. If the number of digits is not correct when entering the command, a syntax error results.
 - Date YY/MM/DD (8 characters)
 - YY: Year (Enter the lower two digits of the year.)
 - MM: Month
 - DD: Day
 - Time HH:MM:SS (8 characters)
 - HH: Hour
 - MM: Minute
 - SS: Second
 - Channel number: 2 characters
 - Relay number: 3 characters

Query

- A question mark is used to specify a query.
- By placing a query after a command or parameter, the setting information of the corresponding command can be queried. Some commands cannot execute queries. For the query syntax of each command, see sections 5.4 to 5.7.

Example 1 SR[p1]? SR? or SR p1? can be executed.

Example 2 SA[p1[,p2]]? SA?, SA p1? or SA p1,p2? can be executed.

Delimiter

- A comma is used as a delimiter.
- Parameters are separated by delimiters.

Sub delimiter

- A semicolon is used as a sub delimiter.
- By separating each command with a sub delimiter, up to 10 commands can be specified one after another. However, the following commands and queries cannot be specified one after another. Use them independently.
 - Output commands other than BO, CS, and IF commands.
 - YO command
 - Queries
- * If there are consecutive sub delimiters, they are considered to be single. In addition, sub delimiters at the front and at the end are ignored.

Example ;SR01,VOLT;;SR02,VOLT;<terminator> is taken to be
SR01,VOLT;SR02,VOLT<terminator>.

Terminator (Terminating character)

Use either of the following two characters for the terminator.

- CR + LF (0DH 0AH in ASCII code.)
- LF (0AH in ASCII code.)

Note

- Do not specify a channel or relay number that is not available on the DX. An error will occur.
 - The total data length from the first character to the terminator must be less than 2047 bytes.
 - Commands are not case sensitive (with the exception of user-specified character strings).
 - All the commands that are listed using sub delimiters are executed even if one of the commands is erroneous.
 - Spaces that are inserted before and after a parameter are ignored. However, if spaces are inserted before a command, after a sub delimiter, or after a query, an error occurs.
-

Response

The DX returns a response (affirmative/negative response) to a command that is delimited by a single terminator*. The controller should follow the one command to one response format. When the command-response rule is not followed, the operation is not guaranteed. For the response syntax, see section 6.1.

* Commands dedicated to RS-422A/485 (see section 5.9) and instrument information output commands (section 5.11) are exceptions.

5.2 A List of Commands

Setting Commands

Command Type	Command Name	Function	Execution Mode	Administrator	User	Page
Setting						
	SR	Sets the input range	Operation mode	Yes	No	5-9
	SO	Sets the computing equation	Operation mode	Yes	No	5-10
	SA	Sets the alarm	Operation mode	Yes	No	5-10
	SD	Sets the date and time	Operation mode	Yes	No	5-11
	SW	Sets the display update rate/auto-save interval	Operation mode	Yes	No	5-11
	SZ	Sets the zone	Operation mode	Yes	No	5-11
	SP	Sets the partial expanded display	Operation mode	Yes	No	5-12
	ST	Sets the tag	Operation mode	Yes	No	5-12
	SX	Sets the group	Operation mode	Yes	No	5-12
	SL	Sets the trip line	Operation mode	Yes	No	5-12
	SG	Sets the message	Operation mode	Yes	No	5-13
	SH	Sets the file header	Operation mode	Yes	No	5-13
	SE	Sets the display direction, background color, trend line width, trip line width, number of grids, scroll time, and scale digit	Operation mode	Yes	No	5-13
	SB	Sets the number of scale divisions, base position of the bar graph, and the display position of the trend scale	Operation mode	Yes	No	5-13
	SV	Sets the moving average of the measured channel	Operation mode	Yes	No	5-13
	SF	Sets the filter	Operation mode	Yes	No	5-14
	SC	Sets the channel display color	Operation mode	Yes	No	5-14
	SQ	Sets the LCD brightness and the screen backlight saver	Operation mode	Yes	No	5-14
	SY	Sets the 4 screen display (only for DX200)	Operation mode	Yes	No	5-14
	SU	Sets the USER key	Operation mode	Yes	No	5-15
	SK	Sets the computation constant	Operation mode	Yes	No	5-15
	SI	Sets the rolling average of the computation channel	Operation mode	Yes	No	5-15
	SJ	Sets the TLOG timer	Operation mode	Yes	No	5-15
	SS	Set the date and time at which to switch the daylight savings time	Operation mode	Yes	No	5-16
	FR	Sets the acquiring interval to the FIFO buffer	Operation mode	Yes	No	5-16
	BA	Sets the application name, the supervisor name, and the manager name	Operation mode	Yes	No	5-16
	BB	Sets the batch number, the lot number, automatic increment of the lot number, and the displayed information	Operation mode	Yes	No	5-17
	BC	Sets the comment number and the character string	Operation mode	Yes	No	5-17
	BD	Sets the alarm delay time	Operation mode	Yes	No	5-17

Yes: Command usable
No : Command not usable

5.2 A List of Commands

Note

- There are two execution modes on the DX. If you attempt to execute a command in a mode that is different from the specification, a syntax error occurs. Use the DS command to switch to the execution mode, then set or control the DX. Query commands can be executed in either mode.
- **Basic setting mode**
Measurement/computation is stopped and settings are changed in this mode.
- **Operation mode**
As a general rule, commands other than those for the basic setting mode described above are used in this mode.
- The administrator and user specifications in the table indicate the user level that is specified using the login function for Ethernet communications. For details, see section 1.2.

Command Type	Command Name	Function	Execution Mode	Administrator	User	Page
Control						
	UD	Switches the screen	Operation mode	Yes	No	5-17
	PS	Starts/stops measurements	Operation mode	Yes	No	5-18
	AK	Confirms the alarm status (alarm acknowledge)	Operation mode	Yes	No	5-18
	EV	Manual sample, manual trigger, snapshot, saving the display data, saving the event data	Operation mode	Yes	No	5-19
	MS	Writes the message (display and save)	Operation mode	Yes	No	5-19
	TL	Starts/stops/resets computation (MATH)/ Clears the computation dropout status display	Operation mode	Yes	No	5-19
	DS	Switches execution modes (operation/basic setting)	All modes	Yes	No	5-19
	LO	Loads the setting data for setting commands	Operation mode	Yes	No	5-19
	LI	Saves the setting data	Operation mode	Yes	No	5-19
	CM	Sets the communication input data	Operation mode	Yes	No	5-20
	EM	Starts/stops the e-mail transmission function	Operation mode	Yes	No	5-20
	KE	Key operation command	Operation mode	Yes	No	5-20

Yes: Command usable

No : Command not usable

Basic Setting Commands

- In order to activate the settings that are changed using the basic setting commands, the settings must be saved using the XE command. Make sure to save the settings with the XE command before changing from the basic setting mode to the operation mode. Otherwise, new settings will not be activated.
- The settings that are returned in response to a query in the basic setting mode will contain the new settings even if they are not saved with the XE command. However, the new settings will not be activated until they are saved. In order to activate the new settings, the XE command must be issued as described earlier. If the settings are not saved or cleared using the XE command and the execution mode is changed from the basic setting mode to the operation mode, the settings that are returned in response to a query will contain the settings that existed before they were changed.

Note

- The settings that are changed using the YA/YK/YN/YQ/YS /YG/YL/YM command are activated after saving the new settings using the XE command and rebooting the DX.
- When executing the YO command, the communication is disconnected.

5.2 A List of Commands

Command Name	Function	Execution Mode	Administrator	User	Page
XA	Sets alarm related settings	Basic setting modeYes		No	5-20
XI	Sets the A/D integral time	Basic setting modeYes		No	5-21
XB	Sets the burn out	Basic setting modeYes		No	5-21
XJ	Sets the RJC	Basic setting modeYes		No	5-21
XV	Sets the scan interval	Basic setting modeYes		No	5-21
XT	Selects the temperature unit	Basic setting modeYes		No	5-21
XS	Sets the channels to display the trend and acquire the data	Basic setting modeYes		No	5-21
XM	Sets the conditions used to acquire display/event data to the internal memory or save the data to the external storage medium	Basic setting modeYes		No	5-21
XU	Sets the channel identification display, memory alarm time, language, whether or not to use the partial expanded display function and the batch function	Basic setting modeYes		No	5-22
XR	Sets the remote action	Basic setting modeYes		No	5-22
XQ	Sets the timer	Basic setting modeYes		No	5-23
RO	Sets the report type and generation time	Basic setting modeYes		No	5-23
RM	Sets the report channel	Basic setting modeYes		No	5-24
XO	Selects the communication interface used to output data residing in the internal memory (display, event, TLOG, manual sampled, and report data) and files on the external storage medium using output commands (ME/MI/MO commands)	Basic setting modeYes		No	5-24
XH	Sets whether or not to use the key login, auto logout, and user ID functions	Basic setting modeYes		No	5-24
XE	Sets whether or not to store the basic settings	Basic setting modeYes		No	5-24
XG	Sets the time zone	Basic setting modeYes		No	5-25
XP	Sets the date and time for the memory timeup	Basic setting modeYes		No	5-25
YA	Sets the IP address, subnet mask, and default gateway	Basic setting modeYes		No	5-25
YK	Sets keepalive	Basic setting modeYes		No	5-25
YN	Sets the DNS	Basic setting modeYes		No	5-25
YQ	Sets the communication timeout	Basic setting modeYes		No	5-26
YS	Sets the serial interface	Basic setting modeYes		No	5-26
YO	Loads setting data	Basic setting modeYes		No	5-26
YI	Saves setting data	Basic setting modeYes		No	5-26
YC	Clears the measured/computed data, initializes setup data	Basic setting modeYes		No	5-26
YT	Sets the FTP transfer timing	Basic setting modeYes		No	5-26
YG	Sets whether or not to use the Web server function	Basic setting modeYes		No	5-27
YL	Sets the Modbus master	Basic setting modeYes		No	5-27
YM	Sets the commands for Modbus master	Basic setting modeYes		No	5-27
YU	Sets the contents of the e-mail	Basic setting modeYes		No	5-27
YV	Sets the recipient's address	Basic setting modeYes		No	5-28
YW	Sets the sender's address	Basic setting modeYes		No	5-28
YX	Sets the SMTP server	Basic setting modeYes		No	5-28

Yes: Command usable

No : Command unusable

5.2 A List of Commands

Output Commands

Command Type	Command Name	Function	Execution Mode	Administrator	User	Page
control						
	BO	Sets the output byte order	All modes	Yes	Yes	5-29
	CS	Sets the checksum (This command can be used only during serial communications)	All modes	Yes	Yes	5-29
	IF	Sets the status filter	All modes	Yes	Yes	5-29
	CC	Disconnects an Ethernet connection (This command can be used only during Ethernet communications)	All modes	Yes	Yes	5-29
Setup, measured, and computed data output						
	FC	Outputs screen image data	All modes	Yes	Yes	5-29
	FE	Outputs setup data	All modes	Yes	Yes	5-29
	FD	Outputs the most recent measured/computed data	Operation mode	Yes	Yes	5-30
	FF	Outputs FIFO data	Operation mode	Yes	Yes	5-30
	FL	Outputs logs, alarm summary, and message summary	All modes	Yes	Yes	5-30
	IS	Outputs status information	All modes	Yes	Yes	5-31
	FU	Outputs user level	All modes	Yes	Yes	5-31
	ME	Outputs data saved in the external storage medium (Either Ethernet or serial communication can be used)	Operation mode	Yes	No	5-31
	MI	Outputs display data and event data acquired in the internal memory (Either Ethernet or serial communication can be used)	Operation mode	Yes	No	5-31
	MO	Outputs TLOG data, manual sampled data, and report data acquired in the internal memory (Either Ethernet or serial communication can be used)	Operation mode	Yes	No	5-32
RS-422A/485 dedicated commands						
	Esc O	Opens the instrument	All modes	Yes	Yes	5-32
	Esc C	Closes the instrument	All modes	Yes	Yes	5-32

Yes: Command usable
No : Command unusable

Maintenance/Test Commands (Available when using the maintenance/test server function via Ethernet communications)

Command	Function	Administrator	User	Page
close	Disconnects the connection between other devices	Yes	No	5-33
con	Outputs connection information	Yes	Yes	5-33
eth	Outputs Ethernet statistical information	Yes	Yes	5-33
help	Outputs help	Yes	Yes	5-33
net	Outputs network statistical information	Yes	Yes	5-33
quit	Disconnects the connection of the device being operated	Yes	Yes	5-34

Yes: Command usable
No : Command unusable

Instrument Information Output Commands (Available when using the instrument information server function via Ethernet communications)

Parameter	Function	Page
all	Outputs all information that are output using the parameters below	5-34
serial	Outputs the serial number	5-34
model	Outputs the manufacturer, model, and firmware version	5-34
host	Outputs the host name	5-34
ip	Outputs the IP address	5-34

5.3 Input Range Parameter

The following tables show which measurement ranges of the instrument correspond to the input types of the SR command (input range setting command), VOLT, TC, RTD, DI, and SQRT. The table also shows the ranges for the upper and lower limits of the span.

DC Voltage (VOLT), Square Root (SQRT)

Measurement Range	Parameter for the SR Command	Value of the Upper and Lower Limits of the Span (Upper and Lower Limits of the Measurement Range)	Value of the Upper and Lower Limits of the SR Command
20 mV	20 mV	-20.00 to 20.00 mV	-2000 to 2000
60 mV	60 mV	-60.00 to 60.00 mV	-6000 to 6000
200 mV	200 mV	-200.0 to 200.0 mV	-2000 to 2000
2 V	2 V	-2.000 to 2.000 V	-2000 to 2000
6 V	6 V	-6.000 to 6.000 V	-6000 to 6000
20 V	20 V	-20.00 to 20.00 V	-2000 to 2000
50 V	50 V	-50.00 to 50.00 V	-5000 to 5000

Thermocouple (TC)

Measurement Range	Parameter for the SR Command	Value of the Upper and Lower Limits of the Span (Upper and Lower Limits of the Measurement Range)	Value of the Upper and Lower Limits of the SR Command
R	R	0.0 to 1760.0°C	0 to 17600
S	S	0.0 to 1760.0°C	0 to 17600
B	B	0.0 to 1820.0°C	0 to 18200
K	K	-200.0 to 1370.0°C	-2000 to 13700
E	E	-200.0 to 800.0°C	-2000 to 8000
J	J	-200.0 to 1100.0°C	-2000 to 11000
T	T	-200.0 to 400.0°C	-2000 to 4000
N	N	0.0 to 1300.0°C	0 to 13000
W	W	0.0 to 2315.0°C	0 to 23150
L	L	-200.0 to 900.0°C	-2000 to 9000
U	U	-200.0 to 400.0°C	-2000 to 4000

Resistance Temperature Detector (RTD)

Measurement Range	Parameter for the SR Command	Value of the Upper and Lower Limits of the Span (Upper and Lower Limits of the Measurement Range)	Value of the Upper and Lower Limits of the SR Command
Pt100	PT	-200.0 to 600.0°C	-2000 to 6000
JPt100	JPT	-200.0 to 550.0°C	-2000 to 5500
Cu10 (GE)*	CU1	-200.0 to 300.0°C	-2000 to 3000
Cu10 (L&N)*	CU2	-200.0 to 300.0°C	-2000 to 3000
Cu10 (WEED)*	CU3	-200.0 to 300.0°C	-2000 to 3000
Cu10 (BAILEY)*	CU4	-200.0 to 300.0°C	-2000 to 3000
Cu10 a = 0.00392 at 20°C*	CU5	-200.0 to 300.0°C	-2000 to 3000
Cu10 a = 0.00393 at 20°C*	CU6	-200.0 to 300.0°C	-2000 to 3000
Cu25 a = 0.00425 at 0°C*	CU25	-200.0 to 300.0°C	-2000 to 3000

* Measurement range that can be specified on models with the Cu10, Cu25 resistance temperature detector option /N1.

5.3 Input Range Parameter

Digital Input (DI)

Measurement Range	Parameter for the SR Command	Value of the Upper and Lower Limits of the Span (Upper and Lower Limits of the Measurement Range)	Value of the Upper and Lower Limits of the SR Command
Voltage	LEVEL	0 or 1 ^{*1}	0 or 1
Contact	CONT	0 or 1 ^{*2}	0 or 1

*1: "0" when less than 2.4 V, "1" when greater than or equal to 2.4 V.

*2: "0" when contact is OFF, "1" when contact is ON.

Note

For the measurement accuracy of each measurement range, see the DX100/DX200 User's Manual (IM04L01A01-01E/IM04L02A01-01E)

5.4 Setting Commands (Setting)

SR Sets the input range

When setting channels to skip

Syntax SR p1,p2<terminator>
 p1 Channel number (DX100: 01 to 12,
 DX200: 01 to 30)
 p2 Range mode (SKIP)

Query SR[p1]?

Example Skips channel 01.

SR 01,SKIP

- Description**
- This command cannot be specified while measurement/computation is in progress or while a report is being created.
 - Measurements are not made on channels that are set to SKIP.

When setting the channels to voltage, thermocouple, RTD, or digital input

Syntax SR p1,p2,p3,p4,p5<terminator>
 p1 Channel number (DX100: 01 to 12,
 DX200: 01 to 30)
 p2 Input type
 VOLT DC VOLTAGE
 TC Thermocouple
 RTD Resistance temperature detector
 DI Digital input
 p3 Measurement range
 p4 Lower limit of span
 p5 Upper limit of span

Query SR[p1]?

Example Set the input type for channel 01 to thermocouple type R, span lower limit to 0°C, and span upper limit to 1760.0°C.
 SR 01,TC,R,0,17600

- Description**
- This command cannot be specified while measurement/computation is in progress or while a report is being created.
 - Set parameters p3, p4, and p5 according to the table in section 5.3.
 - For parameters p4 and p5, enter a value using 5 digits or less excluding the decimal. The decimal position is fixed to the position indicated in the table in section 5.3.

When computing the difference between channels

Syntax SR p1,p2,p3,p4,p5,p6,p7<terminator>
 p1 Channel number (DX100: 01 to 12,
 DX200: 01 to 30)
 p2 Range mode (DELTA)
 p3 Input type
 VOLT DC VOLTAGE
 TC Thermocouple

RTD Resistance temperature detector
 DI Digital input
 p4 Measurement range
 p5 Lower limit of span
 p6 Upper limit of span
 p7 Reference channel (DX100: 01 to 12,
 DX200: 01 to 30)

Query SR[p1]?

Example Set the range mode of channel 10 to the difference computation between channels with the reference channel set to 01 and set the input type to TC. Set the range to R. Set the span lower limit to 10.0°C and span upper limit to 100.0°C.

SR 10,DELTA,TC,R,100,1000,01

- Description**
- This command cannot be specified while measurement/computation is in progress or while a report is being created.
 - Set parameters p4, p5, and p6 according to the table in section 5.3.
 - For parameters p5 and p6, enter a value using 5 digits or less, excluding the decimal. The decimal position is fixed to the position indicated in the table in section 5.3.

When setting the scaling

Syntax SR p1,p2,p3,p4,p5,p6,p7,p8,p9,p10
 <terminator>
 p1 Channel number (DX100: 01 to 12,
 DX200: 01 to 30)
 p2 Range mode (SCALE)
 p3 Input type
 VOLT DC VOLTAGE
 TC Thermocouple
 RTD Resistance temperature detector
 DI Digital input
 p4 Measurement range
 p5 Lower limit of span
 p6 Upper limit of span
 p7 Scaling lower limit (-30000 to 30000)
 p8 Scaling upper limit (-30000 to 30000)
 p9 Scaling decimal position (0 to 4)
 p10 Unit (Up to 6 characters)

Query SR[p1]?

Example Convert the DC voltage measured on channel 02 to a DC current. Set the measurement range to 6 V, span lower limit to 1 V, span upper limit to 5 V, scaling lower limit to 1.00 A, and scaling upper limit to 5.00 A.
 SR 02,SCALE,VOLT,6V,1000,5000,100,500,2,A

- Description**
- This command cannot be specified while measurement/computation is in progress or while a report is being created.
 - Set parameters p4, p5, and p6 according to the table in section 5.3.

5.4 Setting Commands (Setting)

- For parameters p5 and p6, enter a value using 5 digits or less excluding the decimal. The decimal position is fixed to the position indicated in the table in section 5.3.
- For parameters p7, p8, and p9, either set all three parameters or omit all three parameters.

When setting the square root

Syntax SR p1,p2,p3,p4,p5,p6,p7,p8,p9<terminator>
p1 Channel number (DX100: 01 to 12, DX200: 01 to 30)
p2 Range mode (SQRT)
p3 Measurement range
p4 Lower limit of span
p5 Upper limit of span
p6 Scaling lower limit (-30000 to 30000)
p7 Scaling upper limit (-30000 to 30000)
p8 Scaling decimal position (0 to 4)
p9 Unit (Up to 6 characters)

Query SR[p1]?

Example Convert the DC voltage measured on channel 01 to the amount of flow using the square root computation. Set the measurement range to 6 V, span lower limit to 1 V, span upper limit to 5 V, scaling lower limit to 10.0 m³/s, and scaling upper limit to 100.0 m³/s.
SR 01,SQRT,6V,1000,5000,100,1000,1,m3/S

- Description**
- This command cannot be specified while measurement/computation is in progress or while a report is being created.
 - Set parameters p3, p4, and p5 according to the table in section 5.3.
 - For parameters p4 and p5, enter a value using 5 digits or less excluding the decimal. The decimal position is fixed to the position indicated in the table in section 5.3.
 - For parameters p6, p7, and p8, either set all three parameters or omit all three parameters.

SO Sets the computing equation

Syntax SO p1,p2,p3,p4,p5,p6,p7<terminator>
p1 Computation channel number (DX100: 31 to 42, DX200: 31 to 60)
p2 Turn ON/OFF computation
p3 Computing equation (Up to 40 characters)
p4 Lower limit of span(-9999999 to 99999999)
p5 Upper limit of span(-9999999 to 99999999)
p6 Decimal position of span (0 to 4)
p7 Unit (Up to 6 characters)

Query SO[p1]?

Example Set the computation channel to 31, the computation to ON, the computing equation to the sum of channel 01 and 02, span lower limit to -10.0000, span upper limit to 15.0000, and the unit to V.
SO 31,ON,01+02,-100000,150000,4,V

- Description**
- This command can be used on models with the computation function option /M1.
 - This command cannot be specified while measurement/computation is in progress or while a report is being created.
 - For computing equations, see the DX100/DX200 User's Manual.
 - For parameters p4 and p5, enter a value using 7 digits or less ,excluding the decimal, for negative numbers and 8 digits or less for positive numbers.
 - For parameters p4, p5, and p6, either set all three parameters or omit all three parameters.

SA Sets the alarm

When not using the alarm

Syntax SA p1,p2,p3<terminator>
p1 Channel number (DX100: 01 to 12 or 31 to 42, DX200: 01 to 30)
p2 Alarm number (1 to 4)
p3 Alarm ON/OFF state (OFF)

Query SA[p1[,p2]]?

Example Set off the alarm number 1 of channel 10.
SA 10,1,OFF

Description Computation channels (DX100: 31 to 42, DX200: 31 to 60) can be configured on products with the computation function option /M1.

When using the alarm

Syntax SA p1,p2,p3,p4,p5,p6,p7<terminator>
p1 Channel number (DX100: 01 to 12 or 31 to 42, DX200: 01 to 30)
p2 Alarm number (1 to 4)
p3 Alarm ON/OFF state (ON)
p4 Alarm type
H Upper limit alarm
L Lower limit alarm
h Difference upper-limit alarm
l Difference lower-limit alarm
R Upper limit on rate-of-change alarm
r Lower limit on rate-of-change alarm
T Delay upper limit alarm
t Delay lower limit alarm
(Upper and lower case letters are distinguished.)
p5 Alarm value
p6 Relay setting
ON Relay setting ON
OFF Relay setting OFF

p7 Relay number (DX100: I01 to I06,
DX200: I01 to I06/ I11 to I16/ I21 to
I26, I31 to I36)

Query SA[p1[,p2]]?

Example Set an upper limit alarm (alarm value =
1000) in alarm number 1 of channel 02,
and activate relay number 1 when an alarm
occurs.

SA 02,1,ON,H,1000,ON,I01

- Description**
- When the input range setting (SR command) is set to SKIP, p3 cannot be turned ON.
 - When the computation channel setting (SO command) is turned OFF, p3 cannot be turned ON.
 - The alarm settings are all turned OFF for the following cases.
 - When the input type is changed (VOLT, TC……).
 - When the measurement range is changed.
 - When the span and scaling values are changed during scaling display (includes changing the decimal position).
 - When the computation channel is turned ON/OFF or when the computing equation or the span value is changed on the computation channel.
 - The h and l settings of p4 are valid only when the measurement range is set to computation between channels.
 - If p4 is set to R or r, set the interval for the upper/lower limit on the rate-of-change using the XA command.
 - If p4 is set to T or t, set the alarm delay time for the delay upper/lower limit alarm using the BD command.
 - For the range of alarm values of p5, see the table in section 5.3.
 - Set the alarm value of a computation channel within the range of the span.
 - For the alarm value of p5, enter a value using 5 digits or less, excluding the decimal. For computation channels, enter a value using 8 digits or less, excluding the decimal.
 - An error occurs if a number of a relay that is not installed is specified in p7. For the procedures used to set the relay numbers, see the DX100/DX200 User's Manual.
 - Computation channels (DX100: 31 to 42, DX200: 31 to 60) can be configured on products with the computation function option /M1.
 - For computation channels, the alarm types that can be specified are only H (upper limit alarm), L (lower limit alarm), T (delay upper limit alarm), and t (delay lower limit alarm).

- For computation channels, the alarm hysteresis is fixed to zero. Use the XA command to set the alarm hysteresis.

SD Sets the date and time

Syntax SD p1,p2<terminator>

p1 Date (YY/MM/DD fixed form)
YY Year (00 to 99)
MM Month (01 to 12)
DD Day (01 to 31)

p2 Time (HH/MM/SS fixed form)
HH Hour (00 to 23)
MM Minute (00 to 59)
SS Second (00 to 59)

Query SD?

Example Set the internal clock to 13:00:00,
October 1, 1999.
SD 99/10/01,13:00:00

- Description**
- The form of p1 and p2 is fixed to 8 characters. Use the following form. Do not enter spaces in between the digits, as an error will occur.
p1 = YY/MM/DD (Lower two digits of the year/month/day)
p2 = HH:MM:SS (Hour:minute:second)

SW Sets the display update rate/ auto-save interval

Syntax SW p1,p2<terminator>

p1 Display update rate (15s, 30s, 1MIN, 2MIN, 5MIN, 10MIN, 20MIN, 30MIN, 1H, 2H, 4H, 10H)

p2 Auto-save interval (10MIN, 20MIN, 30MIN, 1H, 2H, 3H, 4H, 6H, 8H, 12H, 1DAY, 2DAY, 3DAY, 5DAY, 7DAY, 10DAY, 14DAY, 31DAY)

Query SW?

Example Set the display update rate to one minute and the auto-save interval to 10 minutes.
SW 1MIN,10MIN

- Description**
- This command cannot be specified while measurement is in progress.
 - The selectable auto-save interval (p2) varies depending on the display update rate (p1) setting. For details, see the DX100/DX200 User's Manual.
 - 15S and 30S of p1 apply only to models DX102, DX104, DX204, and DX208.
 - The p2 setting is valid when the saving method to the external storage medium is set to auto using the XM command (p1 of the XM command is set to AUTO).

SZ Sets the zone

Syntax SZ p1,p2,p3<terminator>

p1 Channel number (DX100: 01 to 12 or 31 to 42, DX200: 01 to 30)

p2 Zone lower limit (0 to 95)[%]

5.4 Setting Commands (Setting)

Query p3 Zone upper limit (5 to 100)[%]
SZ[p1]?
Example Display channel 02 in a zone between 30%
 and 50%.
 SZ 02,30,50

- Description • Computation channels (DX100: 31 to 42, DX200: 31 to 60) can be configured on products with the computation function option /M1.
- The total display width of the screen in the direction of the amplitude is taken to be 100%.
 - The zone width must be at least 5%.
 - Set the parameters for the zone upper and lower limits so that the upper limit is greater than the lower limit.

SP Sets the partial expanded display

Syntax SP p1,p2,p3,p4<terminator>
p1 Channel number (DX100: 01 to 12 or 31 to 42, DX200: 01 to 30)
p2 Enable/disable (ON/OFF) the partial expansion setting.
p3 Boundary position (1 to 99)[%]
p4 Boundary value
Query SP[p1]?
Example Partially expand the display of channel 01. Set the boundary position to 25% and the boundary value to 1.00 V.
 SP 01,ON,25,100

- Description • Computation channels (DX100: 31 to 42, DX200: 31 to 60) can be configured on products with the computation function option /M1.
- When the input range setting (SR command) is set to SKIP, p2 cannot be turned ON.
 - When the computation channel setting (SO command) is turned OFF, p2 cannot be turned ON.
 - The range of the upper and lower limits of the span (scaling upper and lower limits when scaling is enabled) is taken to be 100% for parameter p3.
 - Parameter p4 can be set in the range (span upper limit -1) to (span lower limit +1). If scaling is enabled, the range is (scaling upper limit -1) to (scaling lower limit +1).
 - The decimal position and the number of digits become the same as the span and scaling settings (see the SR command).
 - This command cannot be specified unless the partial expanded display function (p4) of the XU command is set to USE.
 - This command cannot be specified if the partial expanded display range does not exist (when the span width is set to 1, for example).

ST Sets the tag

Syntax ST p1,p2<terminator>
p1 Channel number (DX100: 01 to 12 or 31 to 42, DX200: 01 to 30)
p2 Tag (Up to 16 characters)
Query ST[p1]?
Example Set the tag of channel 02 to TAG2.
 ST 02,TAG2

- Description • For the characters that can be used for the tags, see appendix 1, "ASCII Character Codes." Note that semicolons and commas cannot be used.
- Computation channels (DX100: 31 to 42, DX200: 31 to 60) can be configured on products with the computation function option /M1.

SX Sets the group

Syntax SX p1,p2,p3<terminator>
p1 Group number (1 to 4)
p2 Group name (Up to 16 characters)
p3 Channel construction
Query SX[p1]?
Example Set channels 01, 03, 04 to 06 to group number 1, and group name is GROUP2.
 SX 1,GROUP2,01.03.04-06
 Set the channel configuration by using periods "." to separate each channel or by using a hyphen "-" to specify a range of channels.

- Description • An error occurs if a number of a channel that is not installed in the instrument is specified.
- An error occurs if a number of a computation channel that is not provided on the instrument is specified.
 - For the characters that can be used for the group name, see appendix 1, "ASCII Character Codes." Note that semicolons and commas cannot be used.

SL Sets the trip line

Syntax SL p1,p2,p3,p4,p5<terminator>
p1 Group number (1 to 4)
p2 Number of trip line (1 to 4)
p3 Turn ON/OFF the trip line display
p4 Display position (0 to 100)[%]
p5 Display color (RED, GREEN, BLUE, B.VIOLET, BROWN, ORANGE, Y.GREEN, LIGHTBLUE, VIOLET, GRAY, LIME, CYAN, DARKBLUE, YELLOW, LIGHTGRAY, PURPLE)
Query SL[p1[,p2]]?
Example Display trip line 1 in red for group 1.
 SL 1,1,ON,RED

- Description The total display width of the screen in the direction of the amplitude is taken to be 100%.

SG Sets the message

Syntax SG p1,p2<terminator>
 p1 Message number (1 to 8)
 p2 Message (Up to 16 characters)

Query SG[p1]?

Example Set character string "MESSAGE1" in message number 1.
 SG 1,MESSAGE1

Description For the characters that can be used for the message, see appendix 1, "ASCII Character Codes." Note that semicolons and commas cannot be used.

SH Sets the file header

Syntax SH p1,p2,p3<terminator>
 p1 Header for the files saved to the external storage medium (Up to 32 characters)
 p2 Directory (Up to 8 characters)
 p3 Data to be saved to the external storage medium (UNSAVE, ALL)

Query SH?

Example Add a header, DATA1 and save the file to the DATAFILE directory. Save only the data in the internal memory that has not been saved.
 SH DATA1,DATAFILE,UNSAVE

Description

- "Data to be saved to the external storage medium" includes the display, event, TLOG, manual sampled, and report data.
- Parameter p3 is valid when the saving method to the external storage medium is set to manual using the XM command (parameter p1 of the XM command is set to MANUAL).

SE Sets the display direction, background color, trend line width, trip line width, number of grids, scroll time, and scale digit

Syntax SE p1,p2,p3,p4,p5,p6,p7,p8<terminator>
 p1 Display direction of the trend waveform (HORIZONTAL, VERTICA, HORIZON2)
 p2 Display direction of the bar graph waveform (HORIZONTAL, VERTICAL)
 p3 Background color (WHITE, BLACK)
 p4 The line width of the trend (1 to 3)[dot]
 p5 The width of the trip line (1 to 3)[dot]
 p6 Number of grids (4 to 12, AUTO)
 p7 The time interval (scroll time) for switching displayed group (5s, 10s, 20s, 30s, 1min)
 p8 Scale digit (NORMAL, FINE)

Query SE?

Example Set the display direction of the trend waveform to horizontal, the direction of the bar graph to vertical, the background color to white, the line width of the trend to 1 dot, the width of the trip line to 2 dots, the number of grids to 10, the time interval for switching displayed group to 20s, and the scale digit to NORMAL.
 SE HORIZONTAL,VERTICAL,WHITE,1,2,10,20s,NORMAL

SB Sets the number of scale divisions, base position of the bar graph, and the display position of the trend scale

Syntax SB p1,p2,p3,p4<terminator>
 p1 Channel number (DX100: 01 to 12 or 31 to 42, DX200: 01 to 30)
 p2 Number of scale divisions (4 to 12, C10)
 p3 Base position of the bar graph display (NORMAL, CENTER)
 p4 Position of the scale for the trend display (OFF, DX100: 1 to 6, DX200: 1 to 10)

Query SB[p1]?

Example Set the number of scale divisions of the bar graph of channel 02 to 5, and display the bar graph from the span lower limit (scaling lower limit if scaling is enabled). Display the scale at the third position.
 SB 02,5,NORMAL,3

Description

- Computation channels (DX100: 31 to 42, DX200: 31 to 60) can be configured on products with the computation function option /M1.
- The base position (p3) is valid when the display direction of the bar graph is set to HORIZONTAL. Use the SE command to set the display direction of the bar graph.

SV Sets the moving average of the measured channel

Syntax SV p1,p2<terminator>
 p1 Channel number (DX100: 01 to 12, DX200: 01 to 30)
 p2 Number of times to measure the moving average (OFF, 2 to 16) [times]

Query SV[p1]?

Example Set the number of times to measure the moving average on channel 02 to 12.
 SV 02,12

Description This command can be used on models DX106, DX112, DX210, DX220, and DX230.

5.4 Setting Commands (Setting)

SF Sets the filter

Syntax SF p1,p2<terminator>
p1 Channel number (DX100: 01 to 04, DX200: 01 to 08)
p2 Filter (OFF, 2S, 5S, 10S)

Query SF[p1]?

Example Set the filter on channel 02 to 2 s.
SF 02,2s

Description • An error occurs if a channel number other than those shown above is specified.
• This command can be used on models DX102, DX104, DX204 and DX208.

SC Sets the channel display color

Syntax SC p1,p2<terminator>
p1 Channel number (DX100: 01 to 12 or 31 to 42, DX200: 01 to 30)
p2 Display color (RED, GREEN, BLUE, B.VIOLET, BROWN, ORANGE, Y.GREEN, LIGHTBLUE, VIOLET, GRAY, LIME, CYAN, DARKBLUE, YELLOW, LIGHTGRAY, PURPLE)

Query SC[p1]?

Example Set the display color of channel 02 to blue.
SC 02,BLUE

Description Computation channels (DX100: 31 to 42, DX200: 31 to 60) can be configured on products with the computation function option /M1.

SQ Sets the LCD brightness and the screen backlight saver

When the screen backlight saver function is OFF

Syntax SQ p1,p2<terminator>
p1 LCD brightness (DX100: 1 to 8, DX200: 1 to 4)
p2 Screen backlight saver function ON/OFF (OFF)

Query SQ?

Example Set the LCD brightness to 2 and the screen backlight saver function to OFF.
SQ 2,OFF

When the screen backlight saver function is ON

Syntax SQ p1,p2,p3,p4<terminator>
p1 LCD brightness (DX100: 1 to 8, DX200: 1 to 4)
p2 Screen backlight saver function ON/OFF (ON)
p3 Time after which to enable the screen saver function (1MIN, 2MIN, 5MIN, 10MIN, 30MIN, 1H)
p4 Factors that causes the screen to return from the saver mode (KEY, KEY+ALM)

Query SQ?

Example Set the LCD brightness to 2, the screen backlight saver function to ON, the time after which to enable the screen backlight saver function to 1MIN, and the factor that causes the screen to return from the saver mode to KEY.
SQ 2,ON,1MIN,KEY

SY Sets the 4 screen display (only for DX200)

Syntax SY p1,p2,p3,p4,p5,p6,p7,p8,p9,p10<terminator>
p1 Four screen display number (1 to 4)
p2 Four screen display name (Up to 16 characters)
p3 The display item of the upper left quadrant of the divided screen (screen 1)
TREND Trend display
DIGITAL Digital display
BAR Bar graph display
OVERVIEW Overview display (Alarm indicator)
ALARM Alarm summary display
MESSAGE Message summary display
MEMORY Memory summary display
MEDIA Medium summary display
p4 The group number (1 to 4) to display in the upper left quadrant of the divided screen (screen 1)
p5 The display item of the lower left quadrant of the divided screen (screen 2), same as the selections for p3.
p6 The group number (1 to 4) to display in the lower left quadrant of the divided screen (screen 2)
p7 The display item of the upper right quadrant of the divided screen (screen 3), same as the selections for p3.
p8 The group number (1 to 4) to display in the upper right quadrant of the divided screen (screen 3)
p9 The display item of the lower right quadrant of the divided screen (screen 4), same as the selections for p3.
p10 The group number (1 to 4) to display in the lower right quadrant of the divided screen (screen 4)

Query SY?

Example Set the four screen display number to 1, four screen display name to 4DISPLAY1, the display item of screen 1 to trend display, the group number to display in screen 1 to 1, the display item of screen

2 to digital display, the group number to display in screen 2 to 2, the display item of screen 3 to bar graph display, the group number to display in screen 3 to 3, the display item of screen 4 to message summary display, and the group number to display in screen 4 to 4, SY 1,4DISPLAY1,TREND,1,DIGITAL,2,BAR,3, MESSAGE,4

Description The p4, p6, p8, and p10 parameters are valid when p3, p5, p7, and p9 are set to a display other than OVERVIEW respectively.

SU Sets the USER key

Syntax SU p1<terminator>

p1 Key action

NONE No action

ALARM ACK Alarm acknowledge

MANUAL SAMPLE Manual sampling

TRIGGER External trigger input (Event data)

MESSAGE1 Write message 1

MESSAGE2 Write message 2

MESSAGE3 Write message 3

MESSAGE4 Write message 4

MESSAGE5 Write message 5

MESSAGE6 Write message 6

MESSAGE7 Write message 7

MESSAGE8 Write message 8

SNAPSHOT Snapshot of the screen

MATH START/STOP Start/Stop MATH

MATH RESET Reset MATH

Query SU?

Example Set the key action to the snapshot of the screen.

SU SNAPSHOT

SK Sets the computation constant

Syntax SK p1,p2<terminator>

p1 Computation constant number (DX100: K01 to K12, DX200: K01 to K30)

p2 Constant (Up to 11 characters)

The range is -9.9999E+29 to -1.0000E-30, 0, and 1.0000E-30 to 9.9999E+29. (The + sign of "E+" can be omitted.)

Query SK[p1]?

Example Set constant 1.0000E-10 for computation constant number K01.

SK K01,1.0000E-10

Description

- This command can be used on models with the computation function option /M1.
- This command cannot be specified while measurement/computation is in progress or while a report is being created.

SI Sets the rolling average of the computation channel

When the rolling average of a computation channel is OFF

Syntax SI p1,p2<terminator>

p1 Computation channel number (DX100: 31 to 42, DX200: 31 to 60)

p2 Rolling average ON/OFF (OFF)

Query SI[p1]?

Example Turn OFF the rolling average of computation channel number 31.

SI 31,OFF

Description This command can be used on models with the computation function option /M1.

When the rolling average of a computation channel is ON

Syntax SI p1,p2,p3,p4<terminator>

p1 Computation channel number (DX100: 31 to 42, DX200: 31 to 60)

p2 Rolling average ON/OFF (ON)

p3 Sampling interval (1S, 2S, 3S, 4S, 5S, 6S, 10S, 12S, 15S, 20S, 30S, 1MIN, 2MIN, 3MIN, 4MIN, 5MIN, 6MIN, 10MIN, 12MIN, 15MIN, 20MIN, 30MIN, 1H)

p4 Number of samples (1 to 64)

Query SI[p1]?

Example Turn the rolling average of computation channel 31 ON, set the sampling interval to 1 minute, and the number of samples to 20.

SI 31,ON,1MIN,20

Description This command can be used on models with the computation function option /M1.

SJ Sets the TLOG timer

Syntax SJ p1,p2,p3<terminator>

p1 Computation channel number (DX100: 31 to 42, DX200: 31 to 60)

p2 Timer (1 to 3)

p3 Conversion of the time unit for TLOG.

SUM computation

OFF No conversion.

/S Convert to a physical amount in unit of seconds that are integrated.

/MIN Convert to a physical amount in unit of minutes that are integrated.

/H Convert to a physical amount in unit of hours that are integrated.

Query SJ[p1]?

Example Set timer 1 to computation channel number 31. No conversion of time unit.

SJ 31,1

5.4 Setting Commands (Setting)

Description • This command can be used on models with the computation function option /M1.

- This command cannot be specified while computation is in progress.
- About p3
In the sum computation, sampled data are summed over the scan interval. However, when a physical value is measured over a period of time, the actual value may not match the computed result. (This is due to the fact that the scan interval and the time unit are different.) In these cases, set p3 to the same unit as the time unit of the physical value. The summed value is calculated according to the following converting equation depending on the parameter.

$$\text{OFF} \quad \Sigma(\text{measured value})$$
$$\text{/S} \quad \Sigma(\text{measured value}) \times \text{scan interval}$$
$$\text{/MIN} \quad \Sigma(\text{measured value}) \times \text{scan interval} / 60$$
$$\text{/HOUR} \quad \Sigma(\text{measured value}) \times \text{scan interval} / 3600$$

The scan interval unit is in seconds.

SS Sets the date and time at which to switch the daylight savings time

When the switching the daylight savings time is OFF

Syntax SS p1,p2<terminator>
p1 Summer time or winter time (SUMMER, WINTER)
p2 Enable/disable (ON/OFF) the switching (OFF)

Query SS[p1]?

Example Set the summer time is OFF.
SS SUMMER,OFF

Description This command can be used on models with the display language code "-2."

When the switching the daylight savings time is ON

Syntax SS p1,p2,p3<terminator>
p1 Summer time or winter time (SUMMER, WINTER)
p2 Enable/disable (ON/OFF) the switching (ON)
p3 Date and time (yy/mm/dd hh fixed form. Insert a space between dd and hh.)
yy Year (00 to 99)
mm Month (01 to 12)
dd Day (01 to 31)
hh Hour (00 to 23)

Query SS[p1]?

Example Set the summer time to the 23rd hour of June 30, 2000.

SS SUMMER,ON,00/06/30 23
(The 23rd hour of June 30, 2000 is set to 0 hour of July 1, 2000.)

Description This command can be used on models with the display language code "-2."

FR Sets the acquiring interval to the FIFO buffer

Syntax FR p1<terminator>
p1 FIFO acquiring interval (125MS, 250MS, 500MS, 1S, 2S)

Query FR?

Example Set the FIFO acquiring interval to 1 s.
FR 1S

Description • 125 MS, 250 MS, and 500 MS apply only to models DX102, DX104, DX204, and DX208.

- Set the acquiring interval to a value greater than the scan interval.
- If the scan interval is set to a value less than the acquiring interval using the XV command or from the screen, the acquiring interval is automatically set equal to the scan interval.
- The DX has a circular FIFO buffer. The measured/computed values are acquired to the internal memory at predetermined time intervals from the time the power is turned ON, and the data are output when a FF command is received. The previous output position is held for each connection and is updated when the next set of data is output with the FF command. Using this functionality, data can be collected without data dropouts if the PC reads the data in the circular buffer before the data are overacquired. This compensates for the communication time differences that result from periodically retrieving data from the DX at a rate determined by the processing power of the measurement PC. For the output flow of FIFO data, see appendix 4.

BA Sets the application name, the supervisor name, and the manager name

Syntax BA p1,p2,p3<terminator>
p1 Application name (Up to 16 characters)
p2 Supervisor name (Up to 16 characters)
p3 Manager name (Up to 16 characters)

Query BA?

Example Set the application name to "A", the supervisor name to "B", and the manager name to "C."
BA A,B,C

Description This command can be used on models with the batch function option /BT1.

BB Sets the batch number, the lot number, automatic increment of the lot number, and the displayed information

Syntax BB p1,p2,p3,p4<terminator>
 p1 Batch number (Up to 16 characters)
 p2 Lot number (0 to 9999)
 p3 Enable/disable automatic increment of the lot number (ON, OFF)
 p4 Displayed information (BATCH, TIME)

Query BB?

Example Set the batch number to "LOT", the lot number to "2", enable automatic increment of the lot number, and set the displayed information to "BATCH."
 BB LOT,2,ON,BATCH

Description This command can be used on models with the batch function option /BT1.

BC Sets the comment number and the character string

Syntax BC p1,p2<terminator>
 p1 Comment number (1 to 3)
 p2 Character string (Up to 32 characters)

Query BC?

Example Set the character string "COMMENT" to the comment number 1.
 BC 1,COMMENT

Description This command can be used on models with the batch function option /BT1.

BD Sets the alarm delay time

Syntax BD p1,p2<terminator>
 p1 Channel number (01 to 60)
 p2 Alarm delay time (1 to 3600)[s]

Query BD[p1]?

Example Set the alarm delay time for channel 01 to 120 s.
 BC 01,120

5.5 Setting Commands (Control)**UD** Switches the screen.

When switching the screen back to the screen that existed before settings were changed using the communication commands.

Syntax UD p1<terminator>
 p1 Switching the screen (0)

Example Switch the screen back to the screen that existed before settings were changed using communication commands.
 UD 0

When changing to 1 screen display

Syntax UD p1,p2,p3<terminator>
 p1 Switching the screen (1)
 p2 Display item

TREND	Trend display
DIGITAL	Digital display
BAR	Bar graph display
OVERVIEW	Overview display (Alarm indicator)
ALARM	Alarm summary display
MESSAGE	Message summary display
MEMORY	Memory summary display

p3 Group number (1 to 4)

Example Set the display to 1 screen display, display the trend, and set the group number to 4.
 UD 1,TREND,4

When switching to 4 screen display (only for DX200)

Syntax UD p1,p2,p3,p4,p5,p6,p7,p8,p9<terminator>
 p1 Switching the screen (2)
 p2 The display item of the upper left quadrant of the divided screen (screen 1)

TREND	Trend display
DIGITAL	Digital display
BAR	Bar graph display
OVERVIEW	Overview display (Alarm indicator)
ALARM	Alarm summary display
MESSAGE	Message summary display
MEMORY	Memory summary display

p3 The group number (1 to 4) to display in the upper left quadrant of the divided screen (screen 1)

p4 The display item of the lower left quadrant of the divided screen (screen 2), same as the selections for p2.

5.5 Setting Commands (Control)

- p5 The group number (1 to 4) to display in the lower left quadrant of the divided screen (screen 2)
- p6 The display item of the upper right quadrant of the divided screen (screen 3), same as the selections for p2.
- p7 The group number (1 to 4) to display in the upper right quadrant of the divided screen (screen 3)
- p8 The display item of the lower right quadrant of the divided screen (screen 4), same as the selections for p2.
- p9 The group number (1 to 4) to display in the lower right quadrant of the divided screen (screen 4)

Example Set the screen to four screen display, the display item of screen 1 to trend display, the group number to display in screen 1 to 1, the display item of screen 2 to digital display, the group number to display in screen 2 to 2, the display item of screen 3 to bar graph display, the group number to display in screen 3 to 3, the display item of screen 4 to message summary display, and the group number to display in screen 4 to 4,
UD 2,TREND,1,DIGITAL,2,BAR,3,MESSAGE,4

Description The p3, p5, p7, and p9 parameters are valid when p2, p4, p6, and p8 are set to a display other than the OVERVIEW, respectively.

When displaying the 4 screen display set with the SY command (only for DX200)

Syntax UD p1,p2<terminator>

p1 Switching the screen (3)

p2 4 screen display number (0 to 4)

0 Set the screen to the 4 screen display of which parameter p1 was set to 2 with the UD command. This setting (p1 = 3, p2 = 0) is valid only when the 4 screen display is enabled by setting p1 to 2 beforehand.

1 Display the screen of 4 screen display number 1 that was specified with the SY command.

2 Display the screen of 4 screen display number 2 that was specified with the SY command.

3 Display the screen of 4 screen display number 3 that was specified with the SY command.

4 Display the screen of 4 screen display number 4 that was specified with the SY command.

Example Display the screen of 4 screen display number 1 that was specified with the SY command.
UD 3,1

When turning ON or OFF automatic switching of the displayed groups, switching to all channel display from group display or vice versa, turning ON or OFF the scales, and turning ON or OFF the numerical section on the trend screen

Syntax UD p1,p2,p3,p4,p5<terminator>

p1 Switching the screen (4)

p2 Enables/disables automatic switching of the displayed groups (ON, OFF)

p3 Switches all channel display and group display (ALL, GROUP)

p4 Turns the scale display ON/OFF (ON/OFF)

p5 Turns the numerical display section ON/OFF (ON, OFF)

Example Enables the automatic switching of the displayed groups, switches to group display from all channel display, turns ON the scale display, and turns OFF the numerical section.
UD 4,ON,GROUP,ON,OFF

- Description**
- Parameter p2 is valid on the trend, digital, or bar graph screens. Automatically switches the displayed groups. Use the SE command to set the switching interval (scroll time).
 - Parameters p3 and p4 are valid on the trend screen.
 - Parameter p5 is valid on the trend screen or on the trend screen on the 4 screen display.

PS Starts/Stops measurements

Syntax PS p1<terminator>

p1 Starts/Stops measurements

0 Start

1 Stop

Example Start measurement.
PS 0

Description Acquires the display, event, and report data to the internal memory when the measurement is started.

AK Confirms the alarm status (alarm acknowledge)

Syntax AK p1<terminator>

p1 Executes alarm acknowledge (0)

Example Confirm the current held condition of the alarm (executes alarm acknowledge).
AK 0

EV Manual sample, Manual trigger, snapshot, saving display data, and saving event data

Syntax EV p1<terminator>
 p1 Operation type
 0 Perform manual sampling.
 1 Activate manual trigger.
 2 Snapshot.
 3 Save the display data to the storage medium.
 4 Save the event data to the storage medium.

Example Perform manual sampling.
 EV 1

- Description
- EV3 is valid when display data are being acquired to the internal memory, and the DX100/DX200 is set to store the data to the external storage medium using auto save. The display data residing in the internal memory can be stored to the external storage medium at arbitrary times.
 - EV4 is valid when event data are being acquired to the internal memory in the free mode, and the DX100/DX200 is set to store the data to the external storage medium using auto save. The event data residing in the internal memory can be stored to the external storage medium at arbitrary times.

MS Writes the message (display and save)

Syntax MS p1<terminator>
 p1 Message number (1 to 8)

Example Write the message of message number 8.
 MS 8

- Description This command displays the message to the screen and writes the message into the display data and event data.

TL Starts/stops/resets computation (MATH)/Clears the computation dropout status display

Syntax TL p1<terminator>
 p1 Operation type
 0 Start computation
 1 Stop computation
 2 Reset computation
 3 Clear the computation dropout status display

Example Start computation.
 TL 0

- Description
- This command cannot be executed while setup data are being saved or loaded.
 - This command can be used on models with the computation function option /M1.

DS Switches execution modes (operation/basic setting)

Syntax DS p1<terminator>
 p1 Execution modes
 0 Operation mode
 1 Basic setting mode

Example Set the mode to basic setting mode.
 DS 1

- Description
- The setting p1 to 1 cannot be specified while measurement/computation is in progress, while the external storage medium is being formatted, or while data are being saved to the external storage medium.
 - The setting p1 to 0 cannot be specified while the external storage medium is being formatted or while data are being saved to the external storage medium.
 - In order to activate the settings that are changed using the basic setting commands, the settings must be saved using the XE command. Make sure to save the settings with the XE command before changing from the basic setting mode to the operation mode. Otherwise, new settings will not be activated.

LO Loads the setting data for setting commands

Syntax LO p1<terminator>
 p1 File name (Up to 8 characters)

Example Load the setting data of setting commands from the setup file SETFILE1 (.PNL extension).
 LO SETFILE1

- Description
- This command cannot be used to load the setting data of the basic setting commands. In order to load the setting data of both setting and basic setting commands, use the YO command.
 - This command cannot be specified on models that do not have an external storage device or when a medium is not inserted into the drive.

LI Saves the setting data

Syntax LI p1<terminator>
 p1 File name (Up to 8 characters)

Example Save the setting data of both setting and basic setting commands to the file SETFILE2.
 LI SETFILE2

- Description
- A file extension “.PNL” is attached to the saved file. This command is equivalent to the YI command.
 - This command cannot be specified on models that do not have an external storage device or when a medium is not inserted into the drive.

CM Sets the communication input data

Syntax CM p1,p2<terminator>
 p1 Communication input data number
 (DX100: C01 to C12, DX200: C01 to C30)
 p2 Communication input data
 The range is -9.9999E+29 to -1.0000E-30, 0, and 1.0000E-30 to 9.9999E+29.
 (The + sign of "E+" can be omitted.)
 Example Set the communication input data 1.0000E-10 in the communication input data number C01.
 CM C01,10.0000E02
 Description This command can be used on models with the computation function option /M1.

EM Starts/stops the e-mail transmission function

Syntax EM p1<terminator>
 p1 Starts/Stops the e-mail function
 0 Start
 1 Stop
 Example Start the e-mail function.
 EM 0
 Description Acquires the display, event, and report data to the internal memory when the measurement is started.
 Description For details on the settings for the e-mail transmission function, see sections 2.3 and 2.11.

KE Key operation command

Syntax KE p1<terminator>
 p1 Keys
 F1 to F7 Soft keys 1 to 7
 ESC ESC key
 MENU MENU key
 FUNC FUNC key
 START START key
 STOP STOP key
 USER USER key
 0 TO 9 Number "0" to "9" key
 MINUS "-" key
 DOT "." key
 DISP DISP/ENTER key
 UP Up arrow key
 DOWN Down arrow key
 RIGHT Right arrow key
 LEFT Left arrow key
 Example Press the DISP/ENTER key.
 KE DISP
 Description Operates in the same fashion as the key operation on the DX. For consecutive key operations, transmit the commands in the same order as the key operation on the DX.

5.6 Basic Setting Commands

- In order to activate the settings that are changed using the basic setting commands, the settings must be saved using the XE command. Make sure to save the settings with the XE command before changing from the basic setting mode to the operation mode. Otherwise, new settings will not be activated.
- The settings that are returned in response to a query in the basic setting mode will contain the new settings even if they are not saved with the XE command. However, the new settings will not be activated until they are saved. In order to activate the new settings, the XE command must be issued as described earlier. If the settings are not saved or cleared using the XE command and the execution mode is changed from the basic setting mode to the operation mode, the settings that are returned in response to a query will contain the settings that existed before they were changed.

Note

The settings that are changed using the YA/YK/YN/YQ/YS/YG/YL/YM command are activated after saving the new settings using the XE command and rebooting the DX.

XA Sets alarm related settings

Syntax XA p1,p2,p3,p4,p5,p6,p7,p8<terminator>
 p1 Turn ON/OFF reflash (ON, OFF)
 p2 Relay number set to AND logic (NONE, I01, I01-Ixx)
 Ixx: I02 to I06
 I11 to I16 (only for DX200)
 I21 to I26 (only for DX200)
 I31 to I26 (only for DX200)
 p3 Energize/De-energize the relay (ENERGIZE, DE_ENERGIZE)
 p4 Hold/Not hold the relay (HOLD, NONHOLD)
 p5 Hold/Not hold the alarm status display (HOLD, NONHOLD)
 p6 Interval for the upper limit on the rate-of-change (1 to 15)
 p7 Interval for the lower limit on the rate-of-change (1 to 15)
 p8 Turn ON/OFF the alarm hysteresis (ON, OFF).
 Query XA?
 Example Set relay numbers I01 to I12 to AND logic. Enable reflash. Set the alarm to energizing and hold. Set the alarm

status display to hold. Set the interval for the upper limit on the rate-of-change to 10 and the interval for the lower limit on the rate-of-change to 12. Enable alarm hysteresis.

XA ON,I01-I12,ENERGIZE,HOLD,HOLD,10,12,ON

- Description**
- The interval is set in units of the scan interval. The XV command is used to set the scan interval.
 - The hysteresis setting does not apply to computation channels.

XI Sets the A/D integral time

Syntax XI p1<terminator>
p1 A/D integral time (AUTO, 50HZ, 60HZ, 100MS)

Query XI?

Example Set the A/D integral time to 50 Hz.
XI 50HZ

Description 100 MS is available only on models DX106, DX112, DX210, DX220, and DX230.

XB Sets the burn out

Syntax XB p1,p2<terminator>
p1 Channel number (DX100: 01 to 12, DX200: 01 to 30)
p2 Burn out procedure (OFF, UP, DOWN)

Query XB[p1]?

Example Set to UP (+ overflow) when channel 01 burns out.
XB 01,UP

XJ Sets the RJC

When using the internal compensation circuit

Syntax XJ p1,p2<terminator>
p1 Channel number (DX100: 01 to 12, DX200: 01 to 30)
p2 Reference junction compensation selection (INTERNAL)

Query XJ[p1]?

Example Set the RJC of channel 01 to the internal compensation circuit.
XJ 01,INTERNAL

When using an external RJC

Syntax XJ p1,p2,p3<terminator>
p1 Channel number (DX100: 01 to 12, DX200: 01 to 30)
p2 Reference junction compensation selection (EXTERNAL)
p3 External RJC value (-20000 to 20000)

Query XJ[p1]?

Example Set the reference junction compensation of channel 02 to external and set the compensation value to 0μV.
XJ 02,EXTERNAL,0

Description The unit of p3 is μV.

XV Sets the scan interval

Syntax XV p1<terminator>
p1 Scan interval
Select from 125MS or 250MS on models DX102, DX104, DX204, and DX208.
Select from 1S or 2S on models DX106, DX112, DX210, DX220, and DX230.

Query XV?

Example Set the scan interval to 1s.
XV 1S

Description When the A/D integration time (p1 of XI command) is set to 100 MS on models DX106, DX112, DX210, DX220, and DX230, the scan interval can only be set to 2 s.

XT Selects the temperature unit

Syntax XT p1<terminator>
p1 Temperature unit
C Celsius (°C)
F Fahrenheit (°F)

Query XT?

Example Set the temperature unit to Fahrenheit.
XT F

Description This command can be used on models with the display language code "-2".

XS Sets the channels to display the trend and acquire the data

Syntax XS p1,p2<terminator>
p1 Channel number (DX100: 01 to 12 or 31 to 42, DX200: 01 to 60)
p2 Enable/disable (ON, OFF) displaying the trend and acquiring the data

Query XS[p1]?

Example Enable displaying the trend and acquiring the data on channel 01.
XS 01,ON

Description Computation channels (DX100: 31 to 42, DX200: 31 to 60) can be configured on products with the computation function option /M1.

XM Sets the conditions used to acquire display/event data to the internal memory or save the data to the external storage medium

Syntax XM p1,p2,p3,p4,p5,p6,p7,p8,p9,p10<terminator>
p1 Saving method to the external storage medium (AUTO, MANUAL)
p2 Data type (DISPLAY, EVENT, E+D)
p3 Sample rate of event data (125MS, 250MS, 500MS, 1S, 2S, 10S, 30S, 60S, 120S)

5.6 Basic Setting Commands

p4 Event mode (FREE, TRIGGER, ROTATE)
 p5 Number of block
 When p2 is set to EVENT 1, 2, 4, 8, 16
 When p2 is set to E+D 1, 2, 4
 p6 Event data length (3MIN, 5MIN, 10MIN, 20MIN, 30MIN, 1H, 2H, 3H, 4H, 6H, 8H, 12H, 1DAY, 2DAY, 3DAY, 5DAY, 7DAY, 10DAY, 14DAY, 31DAY)
 p7 Pretrigger (0, 5, 25, 50, 75, 95, 100) [%]
 p8 Turn ON/OFF manual trigger (ON, OFF)
 p9 Turn ON/OFF external trigger (ON, OFF)
 p10 Turn ON/OFF alarm trigger (ON, OFF)

Query XM?

Example Set the saving method to the external storage medium to auto, the data types to both display data and event data, the sample rate to 10 s, the event mode to TRIGGER, the number of blocks to 1, the event data length to 30 minutes, the pre-trigger to 50%, the manual trigger to ON, the external trigger to ON, and the alarm trigger to ON.
 XM AUTO,E+D,10S,TRIGGER,1,30MIN,50,ON,ON,ON

- Description
- The setting of p6 is valid when p1 is AUTO and p4 is FREE.
 - Parameters p3 through p10 are valid when p2 is set to EVENT or E+D.
 - When p2 is set to E+D, p4 cannot be set to FREE.
 - Parameter p3 can be set to 125MS, 250MS, or 500MS on models DX102, DX104, DX204, or DX208.
 - The settings of p5 to p10 are valid when p4 is TRIGGER or ROTATE.
 - The event data length selection (p5) varies depending on the p3 setting and the number of channels that are measuring and computing. For details, see the DX100/DX200 User's Manual.

XU Sets the channel identification display, memory alarm time, language, whether or not to use the partial expanded display function, and whether or not to use the batch function

Syntax XU p1,p2,p3,p4,p5<terminator>
 p1 The display used to identify the measurement/computation channels (TAG, CHANNEL)
 p2 Memory alarm time (1H, 2H, 5H, 10H, 20H, 50H, 100H)
 p3 Language (ENGLISH, JAPANESE, GERMAN, FRENCH)

p4 Use/Not use partial expanded display function (USE, NOT)
 p5 Use/Not use batch function (USE, NOT)

Query XU?

Example Set the display used to identify the measurement/computation channels to channel numbers, the memory alarm length to 1 hour, the language to English, use the partial expansion function and the batch function.
 XU CHANNEL,1H,ENGLISH,USE,USE

- Description
- The memory alarm time (p2) is valid on models with the FAIL/Memory End output relay option /F1.
 - The SP command cannot be specified unless the partial expanded display function (p4) of the XU command is set to USE.
 - Parameter p5 (use/not use the batch function) is valid on models with the optional /BT1 batch function.

XR Sets the remote action

Syntax XR p1,p2<terminator>
 p1 Remote number (1 to 8)
 p2 Remote action
 NONE No action
 ALARM ACK Alarm acknowledge
 MEMORY START/STOP Start/stop measurement
 MANUAL SAMPLE Manual sampling
 TRIGGER External trigger input (event data)
 MESSAGE1 Write message 1
 MESSAGE2 Write message 2
 MESSAGE3 Write message 3
 MESSAGE4 Write message 4
 MESSAGE5 Write message 5
 MESSAGE6 Write message 6
 MESSAGE7 Write message 7
 MESSAGE8 Write message 8
 PANEL1 LOAD Load setting 1
 PANEL2 LOAD Load setting 2
 PANEL3 LOAD Load setting 3
 MATH START/STOP Start/stop MATH
 MATH RESET Reset MATH
 TIME ADJUST Adjust time

Query XR[p1]?

Example Set the remote action of remote number 1 to writing message 1.
 XR 1,MESSAGE1

XQ Sets the timer.**When not using the timer**

Syntax XQ p1,p2<terminator>

p1 Timer number (1 to 3)

p2 Timer type (OFF)

Query XQ[p1]?

Example Turn the number 1 timer OFF.

XQ 1,OFF

Description This command can be used on models with the computation function option /M1.

When using the absolute timer

Syntax XQ p1,p2,p3,p4,p5,p6<terminator>

p1 Timer number (1 to 3)

p2 Timer type (ABSOLUTE)

p3 Interval (1MIN, 2MIN, 3MIN, 4MIN, 5MIN, 6MIN, 10MIN, 12MIN, 15MIN, 20MIN, 30MIN, 1H, 2H, 3H, 4H, 6H, 8H, 12H, 24H)

p4 Reference Time (hh fixed form)

hh Hour (00 to 23)

p5 Reset/not reset the integrated value when the timer expires. (ON/OFF)

p6 Action to take when the timer expires (OFF, DATA SAVE)

Query XQ[p1]?

Example Set an absolute timer to timer number 1. Set the sampling interval to 30 minutes, the reference time to 7 O'clock, reset the integrated value when the timer expires, and set no action when the timer expires.

XQ 1,ABSOLUTE,30MIN,07,ON,NONE

Description

- This command can be used on models with the computation function option /M1.
- The timer expires at the interval specified by parameter 3 from the time specified by p4, and performs the operation set with parameters p5 and p6.

When using the relative timer

Syntax XQ p1,p2,p3,p4,p5<terminator>

p1 Timer number (1 to 3)

p2 Timer type (RELATIVE)

p3 Interval (hh:mm fixed form)

hh Hour (00 to 24)

mm Minute (00 to 59)

Set in the range 00:01 to 24:00

p4 Reset/not reset the integrated value when the timer expires. (ON/OFF)

p5 Action to take when the timer expires (OFF, DATA SAVE)

Query XQ[p1]?

Example Set a relative timer to timer number 1. Set the sampling interval to 1 hour 15 minutes, reset the integrated value when the timer expires, and set no action when the timer expires.

XQ 1,RELATIVE,01:15,ON,NONE

Description

- This command can be used on models with the computation function option /M1.
- The timer expires at the interval specified by parameter p3 from the time the instrument is turned ON, the timer is reset, and when the timer setting is OFF, and performs the operation set with parameters p4 and p5.

RO Sets the report type and generation time.**When report type is set to none**

Syntax RO p1<terminator>

p1 Report type (OFF)

Query RO?

Example Set report to none.

RO OFF

Description This command can be used on models with the computation function option /M1.

For hourly, daily, and daily + monthly reports

Syntax RO p1,p2,p3<terminator>

p1 Report type (HOUR, DAY, DAY+MONTH)

p2 Date of creation (dd fixed form)
dd Day (01 to 28)

p3 Time of creation (h h fixed form)
hh hour (00 to 23)

Query RO?

Example Create a daily report at 9 o'clock everyday (Parameter p2 is invalid in this example).

RO DAY,09

Description This command can be used on models with the computation function option /M1.

For daily+weekly reports

Syntax RO p1,p2,p3<terminator>

p1 Report type (DAY+WEEK)

p2 Day of creation (SUN, MON, TUE, WED, THU, FRI, SAT)

p3 Time of creation (hh fixed form)
hh hour (00 to 23)

Query RO?

Example Create a daily report at 9 o'clock everyday, and a weekly report every Tuesday.

RO DAY+WEEK,TUE,09

Description This command can be used on models with the computation function option /M1.

5.6 Basic Setting Commands

RM Sets the report channel

When not using the report channel

Syntax RM p1,p2<terminator>
p1 Report channel number (DX100: 01 to 12, DX200: 01 to 30)
p2 Use/Not use the report channel (OFF)

Query RM[p1]?

Example Set the report channel of number 1 to unused.
RM 01,OFF

Description This command can be used on models with the computation function option /M1.

When using the report channel

Syntax RM p1,p2,p3,p4<terminator>
p1 Report channel number (DX100: 01 to 12, DX200: 01 to 30)
p2 Use/Not use the report channel (ON)
p3 The measurement/computation channel number for which to create reports (DX100: 01 to 12 or 31 to 42, DX200: 01 to 30)
p4 Summation conversion of the waveform on which integration is to be performed.

OFF no conversion
/S Convert as though the physical values are integrated in units of seconds.
/MIN Convert as though the physical values are integrated in units of minutes.
/H Convert as though the physical values are integrated in units of hours.
/DAY Convert as though the physical values are integrated in units of days.

Query RM[p1]?

Example Use the report channel number 1. Set the measurement/computation channel number for which to create reports to 01, and the summation conversion of the waveform on which integration is to be performed to 1 s.
RM 01,ON,01,/S

Description

- This command can be used on models with the computation function option /M1.
- About p4
Because the sampled data are integrated over each scan interval, the physical value integrated over a given period of time may be different from the actual integrated value. This occurs if the given period is not equal to the scan interval. In these cases, set p4 to the unit of the integration time desired. The

integrated value is found according to the following conversion equations that depend on the p4 parameter.

OFF $\Sigma(\text{Measured value})$
/S $\Sigma(\text{Measured value}) \times \text{scan interval}$
/MIN $\Sigma(\text{Measured value}) \times \text{scan interval}/60$
/HOUR $\Sigma(\text{Measured value}) \times \text{scan interval}/3600$
/DAY $\Sigma(\text{Measured value}) \times \text{scan interval}/86400$

The unit of the scan interval is seconds.

XO Selects the communication interface used to output data residing in the internal memory (display, event, TLOG, manual sampled, and report data) and files on the external storage medium using output commands (ME/MI/MO commands)

Syntax XO p1<terminator>
p1 Communication type
ETHERNET
SERIAL

Query XO?

Example Set the communication interface to Ethernet (the communication interface is used to output data in the internal memory and files on the external storage medium using the ME/MI/MO commands).
XO ETHERNET

Description The p1 parameter can be set on models with the serial interface option /C2 or /C3.

XH Sets whether or not to use the key login, auto logout, and user ID functions

Syntax XH p1,p2,p3<terminator>
p1 Use/not use the key login function (USE, NOT)
p2 Use/not use the auto logout function (ON, OFF)
p3 Use/not use the User ID function (USE, NOT)

Query XH?

Example Use the key login, auto logout, and user ID functions.
XH USE,ON,USE

XE Sets whether or not to store the basic settings

Syntax XE p1<terminator>
p1 Store or discard the settings (STORE, ABORT)

Example Store the basic settings.
XE STORE

Description In order to activate the settings that are changed using the basic setting commands, the settings must be saved using the XE command. Make sure to save the settings with the XE command before changing from the basic setting mode to the operation mode. Otherwise, new settings will not be activated.

XG Sets the time zone

Syntax XG p1<terminator>
p1 The offset time from GMT (-1200 to 1200)
Upper two digits Hours (00 to 12)
Lower two digits Minutes (00 to 59)

Example Set the offset time to 9 hours lead.
XG 0900

Description This command can be used on models with the computation function option /M1.

XP Sets the data and time for the memory timeout

When the memory timeout is set to none

Syntax XP p1<terminator>
p1 Timeout type (OFF)

Query XP?

Example Set the memory timeout to none.
XP OFF

When the timeout type is set to "HOUR", "DAY", or "MONTH"

Syntax XP p1,p2,p3<terminator>
p1 Timeout type (HOUR, DAY, MONTH)
p2 Date of timeout (dd fixed form)
dd Day (01 to 28)
p3 Time of timeout (hh fixed form)
hh hour (00 to 23)

Query XP?

Example The memory timeout occurs at 9 o'clock everyday (Parameter p2 is invalid in this example).
XP DAY,05,09

When the timeout type is set to "WEEK"

Syntax XP p1,p2,p3<terminator>
p1 Timeout type (WEEK)
p2 Day of timeout (SUN, MON, TUE, WED, THU, FRI, SAT)
p3 Time of timeout (hh fixed form)
hh hour (00 to 23)

Query XP?

Example The memory timeout occurs at 9 o'clock every Tuesday.
XP WEEK,TUE,09

YA Sets the IP address, subnet mask, and default gateway

Syntax YA p1,p2,p3<terminator>
p1 IP address (0.0.0.0 to 255.255.255.255)
p2 Subnet mask (0.0.0.0 to 255.255.255.255)
p3 Default gateway (0.0.0.0 to 255.255.255.255)

Query YA?

Example Set the IP address to 192.168.111.24, subnet mask to 255.255.255.0, and default gateway to 0.0.0.0.

YA 192.168.111.24,255.255.255.0,0.0.0.0

Description The settings specified by this command take effect the next time the DX is turned ON.

YK Sets keepalive

Syntax YK p1<terminator>
p1 Enable/Disable keepalive (ON, OFF)

Query YK?

Example Disable keepalive
YK OFF

Description The settings specified by this command take effect the next time the DX is turned ON.

YN Sets the DNS.

When not using the DNS

Syntax YN p1<terminator>
p1 Use/Not use the DNS (OFF)

Query YN?

Example Do not use the DNS.
YN OFF

Description The settings specified by this command take effect the next time the DX is turned ON.

When using the DNS

Syntax YN p1,p2,p3,p4,p5,p6,p7<terminator>
p1 Use/Not use the DNS (ON)
p2 Address of the primary DNS server (0.0.0.0 to 255.255.255.255)
p3 Address of the secondary DNS server (0.0.0.0 to 255.255.255.255)
p4 Host name (Up to 64 characters)
p5 Domain name (Up to 64 characters)
p6 Domain suffix 1 (Up to 64 characters)
p7 Domain suffix 2 (Up to 64 characters)

Query YN?

Example Use the DNS server at 192.168.0.1.
YN 192.168.0.1

Description The settings specified by this command take effect the next time the DX is turned ON.

5.6 Basic Setting Commands

YQ Sets the communication timeout

When not using the timeout

Syntax YQ p1<terminator>
p1 Enable/Disable communication timeout (OFF)

Query YQ?

Example Disable timeout.
YQ OFF

Description The settings specified by this command take effect the next time the DX is turned ON.

When using the timeout

Syntax YQ p1,p2<terminator>
p1 Enable/Disable communication timeout (ON)
p2 Timeout time (1 to 120) [minutes]

Query YQ?

Example Enable communication timeout and set the timeout period to 3 min.
YQ ON,3

Description The settings specified by this command take effect the next time the DX is turned ON.

YS Sets the serial interface

Syntax YS p1,p2,p3,p4,p5,p6<terminator>
p1 Baud rate (1200, 2400, 4800, 9600, 19200, 38400)
p2 Data length (7, 8)
p3 Parity check (NONE, ODD, EVEN)
p4 Handshaking (OFF:OFF, XON:XON, XON:RS, CS:RS)
p5 RS-422A/485 address (01 to 32)
p6 Protocol (NORMAL, MODBUS)

Query YS?

Example Set the baud rate to 9600, the data length to 8, the parity check to ODD, handshaking to OFF:OFF, the RS-422A/485 address to 02, and the protocol to NORMAL.
YS 9600,8,ODD,OFF:OFF,02,NORMAL

Description

- The settings specified by this command take effect the next time the DX is turned ON.
- This command can be used on models with the serial interface option /C2 or /C3.

YO Loads setting data

Syntax YO p1<terminator>
p1 Name of the source file (Up to 8 characters)

Example Load the setting data of both setting and basic setting commands from the setup file SETFILE1 (.PNL extension).
YO SETFILE1

Description

- This command loads the setting data of both setting and basic setting commands. To load only the setting data of setting commands, use the LO command.
- This command cannot be specified on models that do not have an external storage device or when a medium is not inserted into the drive.
- When executing this command, the communication is disconnected.

YI Saves setting data

Syntax YO p1<terminator>
p1 Name of the destination file (Up to 8 characters)

Example Save the setting data of both setting and basic setting commands to the file SETFILE2.
YI SETFILE2

Description

- A file extension “.PNL” is attached to the saved file. This command is equivalent to the LI command.
- This command cannot be specified on models that do not have an external storage device or when a medium is not inserted into the drive.

YC Clears the measured/computed data, initializes setup data

Syntax YC p1<terminator>
p1 Type of data to be cleared or initialized

0	Clear all measured/computed data and initialize the setup data of the setting mode and basic setting mode.
1	Clear all measured/computed data and initialize the setup data of the setting mode.
2	Clear all measured/computed data.

Example Clear all measured/computed data.
YC 2

Description

- The measured/computed data indicates the data residing in the internal memory of the DX.
- This command cannot be specified while the external storage medium is being formatted.

YT Sets the FTP transfer timing

Syntax YT p1,p2<terminator>
p1 Auto transfer when display and event data files are created (ON, OFF)
p2 Auto transfer when report data files are created (ON, OFF)

Query YT?

Example Auto transfer the display and event data files. Do not transfer the report data file.
YT ON,OFF

Description • When the method to save the data to the external storage medium is set to “Auto,” the data files are automatically transferred when they are created. For the methods to save the data to the external storage medium, see the DX100/DX200 User’s Manual.

YG Sets whether or not to use the Web server

Syntax YO p1<terminator>
p1 Use/Not Web server (USE, NOT)

Query YG?

Example Use Web server.
YG USE

Description • For details on the settings for the Web server, see sections 2.3 and 2.9.
• The settings specified by this command take effect the next time the DX is turned ON.

YL Sets the Modbus master

Syntax YL p1,p2,p3<terminator>
p1 Read cycle (125MS, 250MS, 500MS, 1S, 2S, 5S, 10S)
p2 Timeout time (125MS, 250MS, 500MS, 1S, 2S, 5S, 10S, 1MIN)
p3 Number of retrials (OFF, 1, 2, 3, 4, 5, 10, 20)

Query YL?

Example Set the read cycle to 500, timeout time to 250MS, and number of retrials to 2.
YL 500MS,250MS,2

Description • This command is valid when the serial interface protocol is set to “Modbus-M.” For the procedure in setting the serial interface, see section 4.4.
• The settings specified by this command take effect the next time the DX is turned ON.

YM Sets the commands for Modbus master

When the command is not used

Syntax YM p1,p2<terminator>
p1 Registration number (1 to 8)
p2 Command ON/OFF (OFF)

Query YM[p1]?

Example Set the command registration number 1 to OFF.
YM 1,OFF

When the command is used

Syntax YS p1,p2,p3,p4,p5,p6,p7<terminator>
p1 Registration number (1 to 8)
p2 Command ON/OFF (ON)
p3 First channel number (DX100: C01 to C12, DX200: C01 to C30)

p4 Last channel number (DX100: C01 to C12, DX200: C01 to C30)
p5 Slave device address number (1 to 247)
p6 Register number (30001 to 39999, 40001 to 49999, 30001 to 365535, 400001 to 465535)
p7 Data type (INT16, UINT16, INT32_B, INT32_L, UINT32_B, UINT32_L, FLOAT_B, FLOAT_L)

Query YM?

Example Take a 32-bit signed integer assigned to registers 30003 (upper 16 bits) and 30004 (lower 16 bits) in slave device (address number is 5) to the communication input data channel C02.

YM 2,ON,C02,C02,5,30003,INT32_B

Description • This command is valid when the serial interface protocol is set to “Modbus-M.” For the procedure in setting the serial interface, see section 4.4.
• The settings specified by this command take effect the next time the DX is turned ON.

YU Sets the contents of the e-mail

When setting the alarm mail

Syntax YU p1,p2,p3,p4,p5,p6,p7,p8,p9,p10,p11,p12<terminator>
p1 Type (ALARM)
p2 Recipient 1 (ON, OFF)
p3 Recipient 2 (ON, OFF)
p4 Alarm No.1 (ON, OFF)
p5 Alarm No.2 (ON, OFF)
p6 Alarm No.3 (ON, OFF)
p7 Alarm No.4 (ON, OFF)
p8 Instantaneous values (ON, OFF)
p9 URL of the DX (ON, OFF)
p10 Subject (Up to 32 characters)
p11 Header 1 (Up to 64 characters)
p12 Header 2 (Up to 64 characters)

Query YU[p1]?

Example Send alarm mails from alarm no. 1 to 4, to the recipient 1. Attach the instantaneous values but the URL. Set the subject and the header 1 to "ALM" and "LP2" respectively.
YU ALARM,ON,OFF,ON,ON,ON,ON,ON,OFF,ALM,LP2

When setting the scheduled mail

Syntax YU p1,p2,p3,p4,p5,p6,p7,p8,p9,p10,p11,p12<terminator>
p1 Type (TIME)
p2 Recipient 1 (ON, OFF)
p3 Interval for recipient 1 (1H, 2H, 3H, 4H, 6H, 8H, 12H, 24H)

5.6 Basic Setting Commands

p4 Time to send mail to recipient 1 (HH:MM)
p5 Recipient 2 (ON, OFF)
p6 Interval for recipient 2 (1H, 2H, 3H, 4H, 6H, 8H, 12H, 24H)
p7 Time to send mail to recipient 2 (HH:MM)
p8 Instantaneous values (ON, OFF)
p9 URL of the DX (ON, OFF)
p10 Subject (Up to 32 characters)
p11 Header 1 (Up to 64 characters)
p12 Header 2 (Up to 64 characters)

Query YU[p1]?

Example Send scheduled mails to the recipient 1 at 17:15 everyday. Do not attach the instantaneous values. Attach the URL. Set the subject and the header 1 to "GOOD" and "LP2" respectively.
YU TIME,ON,24H,17:15,OFF,,,OFF,ON,GOOD,LP2

When setting the system mail

Syntax YU p1,p2,p3,p4,p5,p6,p7<terminator>
p1 Type (SYSTEM)
p2 Recipient 1 (ON, OFF)
p3 Recipient 2 (ON, OFF)
p4 URL of the DX (ON, OFF)
p5 Subject (Up to 32 characters)
p6 Header 1 (Up to 64 characters)
p7 Header 2 (Up to 64 characters)

Query YU[p1]?

Example Send system mails to the recipient 1 with the URL of the DX attached. Set the subject and the header 1 to "SystemAlert" and "LP2" respectively.
YU SYSTEM,ON,OFF,ON,SystemAlert,LP2

When setting the report mail

Syntax YU p1,p2,p3,p4,p5,p6,p7<terminator>
p1 Type (REPORT)
p2 Recipient 1 (ON, OFF)
p3 Recipient 2 (ON, OFF)
p4 URL of the DX (ON, OFF)
p5 Subject (Up to 32 characters)
p6 Header 1 (Up to 64 characters)
p7 Header 2 (Up to 64 characters)

Query YU[p1]?

Example Send report mails to the recipient 1 with the URL of the DX attached. Set the subject and the header 1 to "Report" and "LP2" respectively.
YU REPORT,ON,OFF,ON,Report,LP2

Description • For details on the system mail, see section 1.2.
• The report mail can be used on models with the computation function option /M1.

• For details on the settings for the e-mail transmission function, see sections 2.3 and 2.11.

YV Sets the recipient's address

Syntax YV p1,p2<terminator>

p1 Recipient
1 Recipient 1
2 Recipient 2
p2 Addresses (Up to 150 characters)

Query YV[p1]?

Example Set the addresses for the recipient 1 to "Cont@good.co.jp" and "Adm@good.co.jp."
YV 1,Cont@good.co.jp Adm@good.co.jp

Description • To specify multiple addresses, delimit the addresses using spaces.
• For details on the settings for the e-mail transmission function, see sections 2.3 and 2.11.

YW Sets the sender's address

Syntax YW p1<terminator>

p1 Sender's address (Up to 64 characters)

Query YW[p1]?

Example Set the sender's addresses to "DX210."
YW DX210

Description For details on the settings for the e-mail transmission function, see sections 2.3 and 2.11.

YX Sets the SMTP server

Syntax YX p1,p2<terminator>

p1 SMTP server's name (Up to 64 characters)
p2 Port number (0 to 65535)

Query YX?

Example Set the SMTP server's name to "mhs.good.co.jp" and the port number to "25."
YX 1,mhs.good.co.jp,25

Description For details on the settings for the e-mail transmission function, see sections 2.3 and 2.11.

5.7 Output Commands (Control)

BO Sets the output byte order

Syntax BO p1<terminator>
 p1 Byte order
 0 Sends MSB first.
 1 Sends LSB first.

Query BO?

Example Output MSB first
 BO 0

Description This command is used to specify the byte order for the numerical data during binary output.

CS Sets the checksum

Syntax CS p1<terminator>
 p1 Use/not use checksum
 0 Not use
 1 Use

Query CS?

Example Use the checksum.
 CS 1

Description This command can be used only during serial communications.

IF Sets the status filter

Syntax IF p1<terminator>
 p1 Status filter value
 (0.0.0.0 to 255.255.255.255)

Query IF?

Example Set the status value to 1.0.4.0.
 IF 1.0.4.0

Description For details, see chapter 7.

CC Disconnects an Ethernet connection

Syntax CC p1<terminator>
 p1 Disconnect the connection (0)

Example Disconnect the connection.
 CC 0

Description This command can be used only during Ethernet communications.

5.8 Output Commands (Setup, measured, and computed data output)

FC Outputs screen image data

Syntax FC p1<terminator>
 p1 Outputs screen image data (GET)

Example Outputs screen image data from the DX.
 FC GET

Description Obtains the screen image data of the current screen and outputs the data in PNG format.

FE Outputs setup data

Syntax FE p1,p2,p3<terminator>
 p1 Output data type
 0 Setup data of the setting commands
 1 Decimal position and unit information
 2 Setup data of the basic setting commands
 3 Decimal and unit information of the most recent TLOG value
 4 Setting data file
 p2 First channel number (DX100: 01 to 12 or 31 to 42, DX200: 01 to 30)
 p3 Last channel number (DX100: 01 to 12 or 31 to 42, DX200: 01 to 30)

Example Output the setup data of the setting commands of channel 1 through 5 from the instrument.
 FE 0,01,05

Description

- Set the parameters for the first and last channel numbers so that the last channel number is greater than or equal to the first channel number.
- The settings of p2 and p3 are valid when p1 = 0, 1, 2, and 3.

5.8 Output Commands (Setup, measured, and computed data output)

FD Outputs the most recent measured/computed data

Syntax FD p1,p2,p3<terminator>
p1 Output data type
0 Output the most recent measured/computed data in ASCII format
1 Output the most recent measured/computed data in binary format.
4 Output the most recent TLOG data in ASCII format.
5 Output the most recent TLOG data in binary format.
p2 First channel number (DX100: 01 to 12 or 31 to 42, DX200: 01 to 30)
p3 last channel number (DX100: 01 to 12 or 31 to 42, DX200: 01 to 30)
Example Output the most recent measured/computed data from channel 1 to 5 in ASCII format.
FD 0,01,05

Description • The most recent measured/computed data indicates the most recent measured/computed data residing in the internal memory when the DX receives the FD command.
• Set the parameters for the first and last channel numbers so that the last channel number is greater than or equal to the first channel number.

FF Outputs FIFO data

Syntax FF p1,p2,p3,p4<terminator>
p1 Operation type
GET Output the data starting from the next to the previous read position
RESEND Retransmit the previous output
RESET Set the read position to the most recent acquire position
GETNEW Output the newest data
p2 First channel number (DX100: 01 to 12 or 31 to 42, DX200: 01 to 30)
p3 last channel number (DX100: 01 to 12 or 31 to 42, DX200: 01 to 30)
p4 The upper limit of number of blocks that are to be loaded (1 to 120)
1 to 240 for models DX102, DX104, DX204 and DX208
1 to 60 for models DX106, DX112, DX210, DX220, and DX230
If the measured/computed data is less than the specified number of blocks, only the available data are transmitted.
Example Output two blocks of FIFO data from channels 1 to 10.
FF GET,01,10,2

Description • The FIFO buffer is of a circular type which overacquires from the oldest data when it is full. The FR command is used to set the acquiring interval.
• There are two types of output method, GET and GETNEW.
GET
Output the specified number of blocks (p4) of FIFO data starting from the next to the previous read position (block). Make sure to read the data within the following buffer period to prevent data dropouts.
• For models DX102, DX104, DX204, and DX208
FIFO buffer length: 240 intervals (scan interval)
Maximum buffer period: 240 x (acquiring period)
• For models DX106, DX112, DX210, DX220, and DX230
FIFO buffer length: 60 intervals (scan interval)
Maximum buffer period: 60 x (acquiring period)
GETNEW
Output the specified number of blocks (p4) of FIFO data back starting from the recent acquire position (block).
• Parameters p2 and p4 are valid when p1 is set to GET or GETNEW.
• If p4 is omitted, all the data of all blocks acquired in the FIFO buffer are output.
• Set the parameters for the first and last channel numbers so that the last channel number is greater than or equal to the first channel number.
• For the output flow of FIFO data, see appendix 4.

FL Outputs communication log

Syntax FL p1,p2<terminator>
p1 Log type
COM Communication
FTPC FTP client
ERR Operation error
KEY Key login
p2 Maximum read length of the log
When p1 is COM: 1 to 200
When p1 is some type other than COM: 1 to 50
Example Output the ten most recent operation error logs.
FL ERR,10
Description • Outputs the log that is saved in the DX.
• If p2 is omitted, all written logs are output.

IS **Outputs status information**

Syntax IS p1<terminator>
 p1 Output status information (0)

Example Output status information.
 IS 0

Description The output status can be masked using the status filter (IF command).

FU **Outputs user level**

Syntax FU p1<terminator>
 p1 Output user information (0)

Example Output user information.
 FU 0

Description Outputs the information of the user currently connected to the DX.

ME **Outputs data saved in the external storage medium**

Syntax ME p1,p2,p3<terminator>
 p1 Operation type
 DIR Output the file list
 GET Output (first time)
 NEXT Output (succeeding times),
 this parameter is used to
 output the remaining data
 when the first output
 operation is not adequate.
 RESEND Retransmit the previous
 output
 DEL Delete
 DIRNEXT Outputs the succeeding file
 list after the file list is
 output using the DIR command.
 The number of output lists is
 the p3 value specified with
 the DIR command. If this
 command is executed after all
 lists have been output, only
 the free space of the storage
 medium is output.

p2 File name (Up to 26 characters)
 Specify with a full path.

p3 The maximum number of file lists to
 be output (1 to 100). All file lists
 in the specified directory are output
 when p3 is omitted.

Example • Output the list of all files in the
 root directory.
 ME DIR,/

 • Output 10 files of the file list of the
 root directory.
 ME DIR,/,10

 • Output the list of all files in the
 DATA0 directory.
 ME DIR,/DATA0/*.*

• Output the list of all display data
 files in the DATA0 directory.
 ME DIR,/DATA0/*.DDS

• Output the data in the file
 72615100.DDS in the DATA0 directory.
 ME GET,/DATA0/72615100.DDS

Description • Parameter p2 is valid when p1 is set to DIR,
 GET, or DEL.
 • Parameter p3 is valid when p1 is set to DIR.
 • This command can be used to output data
 over the communication interface (Ethernet or
 serial) that was selected with the XO
 command.
 • If an error occurs during data transmission,
 (p1=) RESEND can be used to retransmit the
 data.

MI **Outputs display data and event data acquired in the internal memory**

Syntax MI p1,p2,p3,p4<terminator>
 p1 Operation type
 DIR Put the data on standby for
 communication output and
 output data list
 GET Output (first time)
 NEXT Output (succeeding times),
 This parameter is used to
 output the remaining data
 when first output operation
 is not adequate.
 RESEND Retransmit the previous
 output
 SIZE Output the data size
 (capacity)
 p2 Output data type
 DISPLAY Display data
 EVENT Event data
 p3 Block number (1 to 16)
 p4 Output format (FILE, DATA)

Example Output the data in block number 1
 containing display data using the file
 output format.
 MI GET,DISPLAY,1,FILE

Description • Parameter p2 is valid when p1 is set to DIR,
 GET, or SIZE.
 • Parameters p3 and p4 are valid when p1 is
 set to GET or SIZE.
 • This command can be used to output data
 over the communication interface (Ethernet or
 serial) that was selected with the XO
 command.
 • This command outputs the data that have
 been put on standby using (p1=) DIR using
 (p1=) GET. Make sure to put the data on
 standby using DIR before outputting the data
 using GET.

MO Outputs TLOG data, manual sampled data, and report data acquired in the internal memory

Syntax MO p1,p2,p3<terminator>
 p1 Operation type
 DIR Put the data on standby for communication output and output data list
 GET Output (first time)
 NEXT Output (succeeding times), This parameter is used to output the remaining data when first output operation is not adequate.
 RESEND Retransmit the previous output
 SIZE Output the data size (capacity)
 p2 Output data type
 TLOG TLOG data
 MANUAL Manual sampling data
 REPORT Report
 p3 Block number
 When p2 is TLOG 1 to 16
 When p2 is MANUAL 1 to 50
 When p2 is REPORT 1 to 40

Example Output the data in block number 1 containing TLOG data from the instrument.
 MO GET,TLOG,1

Description

- Parameter p2 is valid when p1 is set to DIR, GET, or SIZE.
- Parameter p3 is valid when p1 is set to GET or SIZE.
- This command can be used to output data over the communication interface (Ethernet or serial) that was selected with the XO command.
- This command outputs the data that have been put on standby using (p1=) DIR using (p1=) GET. Make sure to put the data on standby using DIR before outputting the data using GET.

5.9 Output Commands (RS-422A/485 Dedicated Commands)

ESC O Opens the instrument

The ASCII code of **ESC** is 1BH. See appendix 1.

Syntax **ESC** O p1<terminator>
 p1 Instrument's address (01 to 32)

Example Open the instrument at address 01, and enable all commands.

ESC O 01

Description

- Specifies the address of the device with which to communicate.
- Only one instrument can be opened at any given time.
- When an instrument is opened with the ESC O command, any other instrument that is currently open is automatically closed.
- When this command is received correctly, the DX transmits the data "**ESC** O□□."
- Normally, either CR+LF or LF can be used as terminators for communication commands. However, the terminator for this command must be CR+LF.

ESC C Closes the instrument

The ASCII code of **ESC** is 1BH. See appendix 1.

Syntax **ESC** C p1<terminator>
 p1 Instrument's address (01 to 32)

Example Close the instrument with the address 01.
ESC C 01

Description

- Clears the current connection with the instrument.
- When this command is received correctly, the DX transmits the data "**ESC** C □□."
- Normally, either CR+LF or LF can be used as terminators for communication commands. However, the terminator for this command must be CR+LF.

5.10 Maintenance/Test Commands (Available when using the maintenance/test server function via Ethernet communications)

close Disconnects the connection between other devices

Syntax close,p1,p2:p3<terminator>
 p1 Port on the DX side (0 to 65535)
 p2 IP address on the PC side
 (0.0.0.0 to 255.255.255.255)
 p3 Port on the PC side (0 to 65535)

Example close,34159,192.168.111.24:1054
 E0

Description This command cannot be used to disconnect a server port. Also, it cannot disconnect the DX being operated. Use the quit command for this purpose.

con Outputs connection information

Syntax con<terminator>

Example

```
con
EA
00/00/00 12:34:56
```

Active connections

Proto	Local Address	Foreign Address	State
TCP	192.168.111. 24:34159	192.168.111. 24:1053	ESTABLISHED
TCP	0. 0. 0. 0:34155	0. 0. 0. 0:	0 LISTEN
TCP	0. 0. 0. 0:34159	0. 0. 0. 0:	0 LISTEN
TCP	0. 0. 0. 0:34150	0. 0. 0. 0:	0 LISTEN

EN

TCP

Protocol used.

Local Address

The DX's socket address.

Displays "IP address : port number."

Foreign Address

The destination socket address.

Displays "IP address : port number."

State

Connection status

ESTABLISHED

Connection established

eth Outputs Ethernet statistical information

Syntax eth<terminator>

Example

```
eth
EA
00/00/00 12:34:56
```

Ethernet Statistics

Name	In Pkt	In Err	Out Pkt	Out Err	16 Coll
lo0	0	0	0	0	0
mb0	74	0	64	0	0

EN

help Outputs help

Syntax help [,p1]<terminator>

p1 Command name

(close, con, eth, help, net, quit)

Example help

```
EA
con - echo connection information
eth - echo Ethernet information
help - echo help
net - echo network status
quit - close this connection
EN
```

net Outputs network information

Syntax net<terminator>

Example net

```
EA
00/00/00 12:34:56
```

Network Status

```
APP: power on time = 00/00/00 12:34:56
APP: applalive = disable
APP: genedrops = 0
APP: diagdrops = 0
APP: ftpsdrops = 0
TCP: keepalive = 30 s
TCP: connects = 14
TCP: closed = 0
TCP: timeoutdrop = 0
TCP: keepdrops = 0
TCP: sndtotal = 53
TCP: sndbyte = 0
TCP: sndrexmitpack = 0
TCP: sndrexmitbyte = 1
TCP: rcvttotal = 0
TCP: rcvbyte = 0
DLC: 16 collisions = 0
EN
```

TCP: `keepalive`
 Keepalive check cycle

TCP: `connects`
 Total number of established connections.

TCP: `closed`
 Total number of dropped connections.

TCP: `timeoutdrop`
 Total number of dropped connections due to TCP retransmission timeout. When the transmitted packet (the unit of transmitted data) is not received, the packet is automatically retransmitted at a predetermined time interval. If the packet is not received after 14 retransmissions, timeout occurs and the connection is dropped.

TCP: `keepdrops`
 Total number of dropped connections due to TCP keepalive timeout.

TCP: `sndtotal`
 Total number of transmitted packets.

TCP: `sndbyte`
 Total number of transmitted bytes.

TCP: `sndrexitpack`
 Total number of retransmitted packets.

TCP: `sndrexitbyte`
 Total number of retransmitted bytes.

TCP: `rcvttotal`
 Total number of received packets.

TCP: `rcvbyte`
 Total number of received bytes.

DLC: `16 collisions`
 Number of collision incidents. A collision occurs when two or more devices on the network attempt to transmit simultaneously. The tendency for collisions to occur increases when the network is congested. 16 collisions would mean 16 consecutive collision incidents.

quit Disconnects the connection of the device being operated

Syntax `quit<terminator>`

5.11 Instrument Information Output Commands (Available when using the instrument information server function via Ethernet communications)

The instrument information server function interprets one UDP packet to be one command and returns a single packet (containing the DX's information) in response to the command.

Port number 34264/udp (see section 2.1)
 Transfer data ASCII
 Received buffer length 128
 Transmit buffer length 512
 Maximum number of parameters 32

In the command packet, parameters corresponding to the desired information are placed one after another.

Parameter	Description
all	Outputs all information that is output using the parameters below (<code>serial</code> , <code>model</code> , <code>host</code> , <code>ip</code>).
serial	Outputs the serial number.
model	Outputs the manufacturer, model, and firmware version.
host	Outputs the host name (the host name specified in section 2.3).
ip	Outputs the IP address (the IP address specified in section 2.3).

Example Query the IP address and host name. (Of the two frames below, the top frame represents the command packet, the bottom frame represents the response packet.)

```
ip host
```

```
EA
ip = 192.168.111.24
host = DX200-1
EN
```

- Description
- Separate each parameter with one or more blanks (space, tab, carriage return, line feed).
 - Parameters are not case sensitive.
 - Undefined parameters will be ignored.
 - Parameters beyond the 32nd parameter are ignored.

6.1 Response Syntax

The following table shows the types of responses for the various commands described in the previous chapter.

The DX returns a response (affirmative/negative response) to a command that is separated by a single delimiter. The controller should follow the one command to one response format. When the command-response rule is not followed, the operation is not guaranteed.

Function	Command		Response	
		Command Type	Affirmation	Negation
Setting/ Measurement server	Setting command	Setting	Affirmative response	Single negative response or Multiple negative responses
		Control		
	Basic setting command Output command	Control	ASCII output BINARY output	
		Setup, measured, and computed data output		
		RS422-A/485 dedicated		
		No response		

* For the responses to the instrument information server function, see section 6.4.

Note

The "CRLF" used in this section denotes carriage return line feed.

Affirmative Response

When the command is processed correctly, an affirmative response is returned.

Syntax

`E0CRLF`

Example

`E0`

Single Negative Response

When the command is not processed correctly, a single negative response is returned.

Syntax

```
E1_nnn_mmm...mCRLF
nnn      Error number (001 to 999)
mmm...m  Message (Variable length, one line)
_        Space
```

Example

`E1 001 "Syntax error"`

Multiple Negative Responses

- If there is an error in any one of the multiple commands that are separated by sub delimiters, multiple negative response are returned.
- The response is generated for each erroneous command.
- If there are multiple commands that have errors, the negative responses are separated by commas.
- The error position number is assigned to the series of commands in order starting with "1" assigned to the first command.

Syntax

```
E2_ee:nnnCRLF (When there is only one error)
E2_ee:nnn,ee:nnn,...,ee:nnnCRLF (When there are multiple errors)
ee      Error position (01 to 10)
nnn     Error number (001 to 999)
_       Space
```

Example

`E2 02:001`

ASCII Output

The following types of ASCII data are available. For the data formats, see section 6.2. Setting data, basic setting data, decimal position/unit information, measured/computed data, communication log, FTP log, operation error log, key login log, Web operation log, e-mail log, alarm summary, message summary, status information, file list, data list, and user level

Syntax

```

EACRLF
.....CRLF
:
.....CRLF
.....CRLF
ENCRLF
    
```

BINARY Output

Conceptual diagram

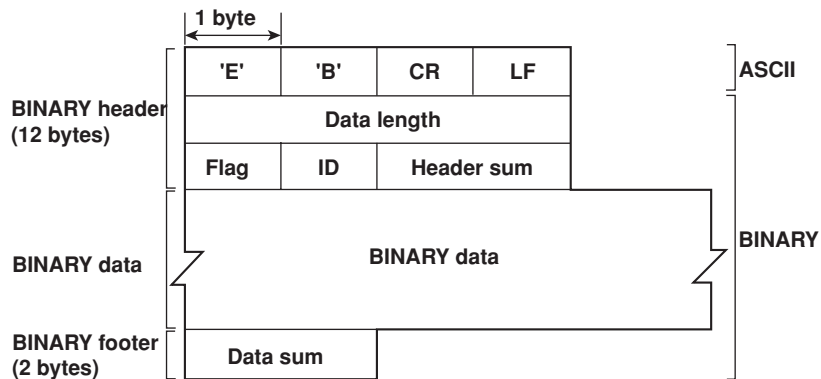

EBCRLF

Indicates that the data are BINARY.

Data length

The byte value of “flag + identifier + header sum + BINARY data + data sum.”

Header sum

The sum value of “data length + flag + identifier.”

BINARY data

For the output format of various data types, see section 6.3.

Data sum

The sum value of “BINARY data.”

Note

The data length of the BINARY header section is output according to the byte order specified with the BO command.

Flag

Bit	Name (abbreviation)	Flag		Meaning of the flag
		0	1	
7	BO	MSB	LSB	Output byte order
6	CS	No	Yes	Existence of a check sum
5	–	–	–	
4	–	–	–	
3	–	–	–	
2	–	–	–	
1	–	–	–	
0	END	Middle	End	In the middle or at the end of the continuous data

- When the BO flag is “0,” the MSB is output first. When the BO flag is “1,” the LSB is output first.
- If the check sum is enabled (parameter = 1) using the CS command parameter, each sum value is inserted in the header sum and data sum sections in the “Conceptual diagram” on the previous page. If the check sum is disabled (parameter = 0), a zero is inserted in the header sum and data sum sections. For a sample program that calculates the sum value, see “Calculating the sum value” on the next page.
- When the amount of data output in response to a ME, MI, or MO command is large, all of the data may not be able to be returned in one output request (parameter GET). In this case the END flag becomes “0.” You must send output requests (parameter NEXT) to receive the rest of the data until the END flag becomes “1.”
- The bits that have “–” for the name and flag are not used. The value is undefined.

Identifier

ID number	BINARY data type	Type	Format
0	Undefined file	file (*.*)	–
1	Measured/computed data	data	Yes
1	FIFO data	data	Yes
2	Display data file	file (*.DDS)	No
3	Event data file	file (*.DEV)	No
4	Manual sampled data file	file (*.DMN)	Yes
5	Hourly report data file	file (*.DHR)	Yes
6	Daily report data file	file (*.DDR)	Yes
7	Weekly report data file	file (*.DWR)	Yes
8	Monthly report data file	file (*.DMR)	Yes
9	TLOG data file	file (*.DTG)	No
10	Setup data file	file (*.PNL)	No
11	Display data	data	Yes
12	Event data	data	Yes
13	Screen image data	file (*.PNG)	–

Yes: disclosed, No: undisclosed, –: common format

- The table above shows the different types of BINARY Data.
- BINARY data come in two types, data and file.
 - Data
 - Measured/computed data can be output using the FD command.
 - FIFO data can be output using the FF command.
 - Display data or event data can be output using the MI command.
 - The data format is disclosed. See section 6.3.
 - File
 - Display data, event data, TLOG data, and setup data files can be used on the standard software DXA100 that came with the package. For details, see the DXA100 STANDARD User’s Manual (IM04L02A01-61E).
 - Files that are in common formats can be opened using software programs that are sold commercially.
 - Other formats are written in ASCII code. A text editor can be used to open these types of files.
- The identifier section in the “Conceptual diagram” on the previous page contains the ID number that indicates the BINARY Data type.

Note

BINARY data that are not indicated in the above table are considered undefined files.

Calculating the sum value

When the CS command parameter is set to "1," check sum values are output only during serial communications. The check sum is the same as that used in the TCP/IP and is derived according to the following algorithm.

Buffer on which the sum value is calculated

- For the header sum, it is calculated from "data length + flag + identifier" (fixed to 6 bytes).
- For the data sum, it is calculated from "BINARY data."



If the data length of the buffer is odd, a "0" is padded so that it is even. (1) through (6) are summed as unsigned two-byte integers (unsigned short). When the digit overflows a "1" is added. Finally, the result is bit-wise inverted.

Sample program

The sum value is determined using the following sample program, and the calculated result is returned. The sum determined by the sample program can be compared with the header sum of the output BINARY header section and the data sum of the output BINARY footer section.

```

/*
 * Sum Calculation Function (for a 32-bit CPU)
 *
 * Parameter buff : Pointer to the top of the data on which the sum is calculated
 * len : Length of the data on which the sum is calculated
 * Returned value : Calculated sum
 */

int cksum(unsigned char *buff, int len)
{
    unsigned short *p; /* Pointer to the next two-byte data word in the buffer that is to be summed. */
    unsigned int csum; /* Checksum value */
    int i;
    int odd;
    csum = 0; /* Initialize. */
    odd = len%2; /* Check whether or not the number of data points is even. */
    len >>= 1; /* Determine the number of data points using a "short" data type. */
    p = (unsigned short *)buff;

    for(i=0;i<len;i++) /* Sum using an unsigned short data type. */
        csum += *p++;

    if(odd){ /* When the data length is odd */
        union tmp{ /* Pad with a 0, and add to the unsigned short data. */
            unsigned short s;
            unsigned char c[2];
        }tmp;
        tmp.c[1] = 0;
        tmp.c[0] = *((unsigned char *)p);
        csum += tmp.s;
    }

    if((csum = (csum & 0xffff) + ((csum>>16) & 0xffff)) > 0xffff)
        /* Add the overflowed digits */
        csum = csum - 0xffff; /* If the digit overflows again, add a 1. */

    return((~csum) & 0xffff);/* bit inversion */
}

```

RS-422A/485 Dedicated Response

The following table shows dedicated commands for the RS-422A/485 interface and their responses.

Command syntax	Meaning	Response
ESC O <u>xx</u> <u>CRLF</u> (_ Space)	Open the instrument	<ul style="list-style-type: none"> Response from the instrument with the specified address ESC O <u>xx</u> <u>CRLF</u> Response when the instrument with the specified address does not exist* None
ESC C <u>xx</u> <u>CRLF</u> (_ Space)	Close the instrument	<ul style="list-style-type: none"> Response from the instrument with the specified address ESC C <u>xx</u> <u>CRLF</u> Response when the instrument with the specified address does not exist* None

* The causes that the condition become "The instrument with the specified address does not exist" is such as a command error, the address not matching that of the instrument, the instrument is not being turned ON, and the instrument not being connected via the serial interface.

- The "xx" in the table indicates the instrument's address. Specify the address that is assigned to the instrument from 01 to 32.
- Only one instrument can be opened at any one time.
- When an instrument is opened with the ESC O command, all commands on the instrument become active.
- When an instrument is opened with the ESC O command, any other instrument that is open is automatically closed.
- Normally, either CR+LF or LF can be used as terminators. However, the terminator for this command must be CR+LF.

Note

The ASCII code of ESC is 1BH. See appendix 1.

6.2 Output Format of ASCII Data

The following types of ASCII data are available. The format for each type is described in this section.

- Setting data/basic setting data
- Decimal position/unit information
- Measured/computed data
- Communication log
- FTP log
- Operation error log
- Key login log
- Web operation log
- E-mail log
- Alarm summary
- Message summary
- Status information
- File list
- Data list
- User level

Note

The “CRLF” used in this section denotes carriage return line feed.

Setting data/basic setting data

- The FE command is used to output the data.
- The setting/basic setting data are output in the order of the listed commands in the table in section 5.2, “A List of Commands.” However, the setting information for the following commands is not output.
 - Setting command (Setting)
SD/FR command
 - Setting command (control)
All commands from UD to CM
 - Basic setting command
XE, YO, YI, and YC commands
- The output format of the setting/basic setting data conforms to the syntax of each command.
- Some commands are output in multiple lines. (Example: Commands that are specified for each channel.)

Syntax

The two-character command name and the succeeding parameters are output in the following syntax.

```
EACRLF  
ttsss...sCRLF  
.....  
ENCRLF
```

```
tt      Command name (SR, SA..., XA, XI...)  
sss...s Setting, basic setting data (variable length, one line)
```

Example

```
EA
SR01,VOLT,20mV,0,20
SR02,VOLT,20mV,0,20
.....
EN
```

Decimal Position/Unit Information

- The FE command is used to output the data.
- The measured/computed data that are output using the FD command contains only the mantissa. By combining with the BINARY display data or the decimal position information obtained with the FE command, the correct measured/computed data can be derived.

Syntax

The data are output in the following syntax.

```
EACRLF
s_kccuuuuuu,ppCRLF
.....
ENCRLF
```

s	Data status
	N : Normal
	D : Differential input
	S : Skip (When the measurement range is set to SKIP for a measurement channel or when the channel is turned OFF for a computation channel)
k	Channel type
	0 : Measurement channel
	A : Computation channel
cc	Channel number
	01 to 60
uuuuuu	Unit information (6 characters, left-justified)
	mV____ : mV
	V____ : V
	^C____ : °C
	xxxxxx : (user-defined character string)
pp	Decimal position (00 to 04)
	No decimal (00000) for 00.
	One digit below the decimal (0000.0) for 01.
	Two digits below the decimal (000.00) for 02.
	Three digits below the decimal (00.000) for 03.
	Four digits below the decimal (0.0000) for 04.
_	Space

Example

```
EA
N 001mV ,01
N 002mV ,01
EN
```

Measured/Computed Data

- The FD command is used to output the data.
- The measured/computed data that are output using the FD command contains only the mantissa. By combining with the BINARY display data or the decimal position information obtained with the FE command, the correct measured/computed data can be derived.

Syntax

The measured/computed data are output in the following syntax along with the date and time information for each channel.

```

EACRLF
DATE_yy/mo/ddCRLF
TIME_hh:mi:ss.mmmtCRLF
s_kcca1a2a3a4uuuuuufdddddE-ppCRLF
.....
ENCRLF

YY          Year (00 to 99)
mo          Month (01 to 12)
dd          Day (01 to 31)
hh          Hour (00 to 23)
mi          Minute (00 to 59)
ss          Second (00 to 59)
mmm        Millisecond (000 to 999. A period is placed between
           seconds and milli-seconds.)
t           Summer time or winter time
           S: summer time
           (Space): winter time
s           Data status
           N : Normal
           D : Differential input
           S : Skip
           O : Over
           E : Error
k           Channel type
           0 : Measurement channel
           A : Computation channel
cc          Channel number
           01 to 60
a1a2a3a4   a1 Alarm status (level 1)
           a2 Alarm status (level 2)
           a3 Alarm status (level 3)
           a4 Alarm status (level 4)
           (Each status is set to H, L, h, l, R, r, T, t, or space.)
           (H : upper limit alarm, L : lower limit alarm, h :
           difference upper-limit alarm, l : difference lower-limit
           alarm, R : upper limit on rate-of-change alarm, r : lower
           limit on rate-of-change alarm, T : delay upper limit
           alarm, t : delay lower limit alarm, space : no alarm)
uuuuuu     Unit information (6 characters, left-justified)
           mV____: mV
           V____: V
           ^C____: °C
           xxxxxx: (user-defined character string)
    
```

f	Sign (+, -)
dddd	Mantissa (00000 to 99999, 5 digits)
	• 8 digits for computed data.
	• For abnormal data (data status is E) or data of which the mantissa or the exponent exceeds the range (data status is O), the mantissa is set to 99999 (99999999 for computed data).
pp	Exponent (00 to 04)
-	Space

Example

```
EA
DATE 99/02/23
TIME 19:56:32.500
N 001h   mV   +12345E-03
N 002   mV   -67890E-01
S 003
EN
```

Note

- Data for non-existing channels are not output (not even the channel number).
- For channels set to skip, output values from alarm status to exponent are spaces.

Communication Log

- The FL command is used to output the data.
- A log of setting/basic setting/output commands and responses is output. Up to 200 logs are retained. Logs that exceed 200 are cleared from the oldest data.

SyntaxEACRLF

yy/mo/dd_hh:mi:ss_n_uuu...ufd_mmm...mCRLF

.....

ENCRLF

yy	Year (00 to 99)
mo	Month (01 to 12)
dd	Day (01 to 31)
hh	Time (00 to 23)
mi	Minute (00 to 59)
ss	Second (00 to 59)
n	Connection ID. A number used to identify the user that is connected.
	0 : serial
	1 to 3 : Ethernet
uuu...u	User name (16 characters)
f	Multiple command flag
	(Space) : single
	* : multiple

If multiple commands are separated by sub delimiters and output at once, "*" is displayed. The multiple commands are divided at each sub delimiter and stored as

6.2 Output Format of ASCII Data

individual logs (1 log for 1 command and 1 log for 1 response).

d Input/Output
> : input
< : output

mmm...m Message (up to 20 characters)

- The communication log contains only the error number and not the error message section..
- Normally, the transfer data are transmitted as they are, but in some cases, a special message is output. The special messages are shown below.

Reception

(Over length) : Command length exceeded.
(Over number) : Number of commands exceeded
(Serial error) : Received an error character through serial communications.

Transmission

(ddd byte) : data output (ddd is the number of data points)
(Login) : login
(Logout) : logout
(Disconnected) : Forced disconnection (occurs when the connection was disconnected when transmitting data using Ethernet)
(Time out) : Timeout, keepalive, TCP retransmission, etc.)
E1 nnn : single negative response. nnn is the error number.
E2 ee:nnn : multiple negative response. ee is the error position, nnn is the error number.

– Space

Example

The following example shows the log when multiple commands separated by sub delimiters, "B01;???;CS1," are transmitted. The commands are separated and output in order with the multiple command flags "*".

```
EA
99/05/11 12:31:11 1 user          *> B01
99/05/11 12:31:11 1 user          *< E0
99/05/11 12:31:11 1 user          *> ???
99/05/11 12:31:11 1 user          *< E2 01:124
99/05/11 12:31:11 1 user          *> CS1
99/05/11 12:31:11 1 user          *< E0
EN
```

FTP Log

- The FL command is used to output the data.
- The FTP client log is output. Up to 50 file transfer logs are retained. Logs that exceed 50 are cleared from the oldest log.
- For the meanings of the error codes, see the DX100/DX200 User's Manual (IM04L01A01-01E/IM04L02A01-01E).

Syntax

```

EACRLF
yy/mo/dd_hh:mi:ss_nnn_XXXXXXXX_k_ffffff_eeeCRLF
.....
ENCRLF

yy          Year (00 to 99)
mo          Month (01 to 12)
dd          Day (01 to 31)
hh          Hour (00 to 23)
mi          Minute (00 to 59)
ss          Second (00 to 59)
nnn         Error number (001 to 999)
XXXXXXXX    Detailed code (9 characters)
k           Server type (FTP destination)
            P : Primary
            S : Secondary
ffffff     File name (8 characters)
eee        Extension (3 characters)
_          Space

```

Example

```

EA
99/07/26 10:00:00          P 72610000 DDR
99/07/27 10:00:00          P 72710000 DDR
99/07/28 10:00:00 123 HOSTADDR P 72810000 DDR
99/07/29 10:00:00 123 HOSTADDR P 72910000 DDR
EN

```

Operation Error Log

- The FL command is used to output the data.
- The operation error log is output. Up to 50 operation error logs are retained. Logs that exceed 50 are cleared from the oldest log.
- Other communication messages (400 to 999) and status messages (500 to 599) are not output.
- For the meanings of the error codes, see the DX100/DX200 User's Manual (IM04L01A01-01E/IM04L02A01-01E).

Syntax

```
EACRLF
yy/mo/dd_hh:mi:ss_nnn_uuu...uCRLF
.....
ENCRLF

yy      Year (00 to 99)
mo      Month (01 to 12)
dd      Day (01 to 31)
hh      Hour (00 to 23)
mi      Minute (00 to 59)
ss      Second (00 to 59)
nnn     Error code (001 to 999)
uuu...u Error message (Up to 80 characters)
_       Space
```

Example

```
EA
99/05/11 12:20:00 212 "Format error."
99/05/11 12:30:00 217 "Unknown file type."
EN
```

Key Login Log

- The FL command is used to output the data.
- A log of users that have logged in and logged out is output. Up to 50 login/logout logs are retained. Logs that exceed 50 are cleared from the oldest log.
- If the power goes down while logged in, you will be logged out. However, it will not be recorded as a logout.
- User number and user name are not output at the time of the logout.

Syntax

```
EACRLF
yy/mo/dd_hh:mi:ss_xxx_nn_uuu...uCRLF
.....
ENCRLF

yy      Year (00 to 99)
mo      Month (01 to 12)
dd      Day (01 to 31)
hh      Hour (00 to 23)
mi      Minute (00 to 59)
ss      Second (00 to 59)
xxx     Login or logout (In_, Out), left-justified
nn      User number (01 to 07)
uuu...u User name (16 characters)
_       Space
```

Example

```
EA
99/05/11 12:20:00 In 01 administrator
99/05/11 12:30:00 Out
99/05/11 12:20:00 In 03 user
99/05/11 12:30:00 Out
EN
```

Web Operation Log

- The FL command is used to output the data.
- The log of operations on the operator page is output. Up to 50 logs are retained. Logs that exceed 50 are cleared from the oldest log.

Syntax

```
EACRLF
yy/mo/dd_hh:mm:ss_ffffff_eee_???...?CRLF
.....
ENCRLF

yy          Year (00 to 99)
mo          Month (01 to 12)
dd          Day (01 to 31)
hh          Hour (00 to 23)
mm          Minute (00 to 59)
ss          Second (00 to 59)
ffffff      Operation code
            SCREEN : Switching screens
            KEY   : Key operation
            MSG   : Setting/writing message
eee         Error code
            All space : succeeded
            001 to 999 : Error code
???...?    Detailed operation code
            When fffffff=SCREEN
yy/mo/dd_hh:mm:ss_ffffff_eee_dddnnCRLF
            dddd  : Screen
                TREND : Trend screen
                DIGIT : Digital screen
                BAR  : Bar graph screen
            nn   : Group number (01 to 04)

            When fffffff=KEY
yy/mo/dd_hh:mm:ss_ffffff_eee_kkkkkCRLF
            kkkkk : Key
                DISP : The DISP/ENTER key
                UP   : The up arrow key
                DOWN : The down arrow key
                LEFT : The left arrow key
                RIGHT: The right arrow key
```

6.2 Output Format of ASCII Data

```
When ffffff=MSG
yy/mo/dd_hh:mm:ss_ffffff_eee_nn_mmm...mCRLF
  nn : Message number (01 to 08)
  mm...m : Message (Up to 16 characters)
  _      Space
```

Example

```
EA
01/02/11 12:20:00 SCREEN 275 TREND 01
01/02/11 12:21:00 SCREEN      BAR  01
01/02/11 12:30:00 KEY         UP
01/02/11 12:31:00 KEY         RIGHT
01/02/11 12:40:00 MSG         05 Hello-Hello
01/02/11 12:41:00 MSG         05 Hello-Hello
EN
```

E-Mail Log

- The FL command is used to output the data.
- The log of e-mail transmission is output. Up to 50 logs are retained. Logs that exceed 50 are cleared from the oldest log.

Syntax

```
EACRLF
yy/mo/dd_hh:mm:ss_fffff_eee_n_uuu...uCRLF
.....
ENCRLF

yy      Year (00 to 99)
mo      Month (01 to 12)
dd      Day (01 to 31)
hh      Hour (00 to 23)
mm      Minute (00 to 59)
ss      Second (00 to 59)
ffffff  E-mail type
ALARM   : Mail at the alarm occurrence/release
TIME    : Mail at the scheduled time
REPORT  : Mail at the report creation
FAIL    : Mail at the recovery from the power failure
FULL    : Mail at the memory end
TEST    : Test mail
ERROR   : Error message mail
eee     Error code
All space : Succeeded
001 to 999 : Error code
n       Recipient code
1       : Recipient 1
2       : Recipient 2
+       : Recipient 1 and Recipient 2
uuu...u Recipient's e-mail address (Up to 30 characters)
_       Space
```

Example

```
EA
01/05/11 12:20:00 ALARM      + notice
01/05/11 12:30:00 REPORT 375 1 user1 user2
EN
```

Alarm Summary

- The FL command is used to output the data.
- The alarm summary is output. Up to 120 alarms are retained. Alarms that exceed 120 are cleared from the oldest alarm.

Syntax

```
EACRLF
yy/mo/dd_hh:mm:ss_kcc_ls_YY/MO/DD_HH:MM:SSCRLF
.....
ENCRLF

yy/mo/dd_hh:mm:ss      Alarm ocurrence time
      YY                Year (00 to 99)
      mo                Month (01 to 12)
      dd                Day (01 to 31)
      hh                Hour (00 to 23)
      mi                Minute (00 to 59)
      ss                Second (00 to 59)

k      Channel type
      0 : Measurement channel
      A : Computation channel

cc     Channel number
      01 to 60

l      Alarm number (1 to 4)

s      Alarm type (H,h,L,l,R,r,T,t)
      01 to 60

YY/MO/DD_HH:MM:SS     Alarm release time
      YY                Year (00 to 99)
      MO                Month (01 to 12)
      DD                Day (01 to 31)
      HH                Hour (00 to 23)
      MM                Minute (00 to 59)
      SS                Second (00 to 59)

-      Space
```

Example

```
EA
01/05/11 12:20:00 001 1L 01/05/11 12:25:00
01/05/11 12:30:00 A31 3t
EN
```

Message Summary

- The FL command is used to output the data.
- The message summary is output. Up to 100 messages are retained. Messages that exceed 100 are cleared from the oldest message.

Syntax

```
EACRLF
yy/mo/dd_hh:mm:ss_nn_mmm...m_uuu...uCRLF
.....
ENCRLF
```

yy	Year (00 to 99)
mo	Month (01 to 12)
dd	Day (01 to 31)
hh	Hour (00 to 23)
mi	Minute (00 to 59)
ss	Second (00 to 59)
nn	Message number (01 to 08)
mmm...m	Message (16 characters. Spaces are embedded when the number of characters is less than 16.)
uuu...u	User name (Up to 16 characters. Output when the key login function is engaged.)
_	Space

Example

```
EA
01/05/11 12:20:00 01 Hello-Hello superstar
01/05/11 12:20:00 03 0123456789abcdef kokoko
EN
```

Status Information

- The IS command is used to output the data.
- The operation status of the DX is output.
- For details related to the status information, see section 7.2, "The Bit Structure of the Status Information."

Syntax

```
EACRLF
ddd.ccc.bbb.aaaCRLF
ENCRLF
```

aaa	Status information 1 (000 to 255)
bbb	Status information 2 (000 to 255)
ccc	Status information 3 (000 to 255)
ddd	Status information 4 (000 to 255)

Example

```
EA
000.000.032.000
EN
```

File List

- The ME command is used to output the data.
- The file list and the file data sizes of the specified directory on the DX's external storage medium are output.

Syntax

```

EACRLF
ffffff_eee_sssssss_yy/mo/dd_hh:mi:ss_l111111111CRLF
.....
zzzzzzz_Kbyte_freeCRLF
ENCRLF

```

```
ffffff  File name (8 characters)
```

When this is a directory, the characters <DIR> is shown at the position displaying the file data size.

```
eee      Extension (3 characters)
```

```
ssssssss Data size of the file (_____0 to 99999999) [byte]
```

```
yy       Year (00 to 99)
```

```
mo       Month (01 to 12)
```

```
dd       Day (01 to 31)
```

```
hh       Hour (00 to 23)
```

```
mi       Minute (00 to 59)
```

```
ss       Second (00 to 59)
```

```
zzzzzzz Free space on the medium (_____0 to 99999999)
```

```
l11111111 ID number(_____0 to 999999999)
```

- This becomes a numerical value only when the file extension is DEV or DDS. This value is specific to the file and is the same as the ID number of the block in the internal memory from which the file originates.

- This becomes a space when the file extension is not DEV or DDS.

- This becomes a "0" if the file was saved using another instrument (DX).

```
-        Space
```

Example

```

EA
XV1    DEV      124 99/02/24 20:07:12      12310
XV1    PNL      1204 99/01/19 01:52:37
DATA   <DIR>    99/01/19 01:23:64
      523 Kbytes free
EN

```

Data List

- The MI/MO command is used to output the data.
- The number of blocks and file names of the specified data in the internal memory are output.
- When the first parameter of the MI/MO command is DIR, the data in the internal memory is put on a standby and the list is output.

Syntax

```

EACRLF
aaCRLF
bb_ffffff_eee_sssss_yy/mo/dd_hh:mi:ssklllllllllCRLF
.....
ENCRLF
    
```

```

aa          Number of valid blocks (00 to 99)
bb          Block number (00 to 99)
ffffff     File name (8 characters)
eee        Extension (3 characters)
ssssss     Number of collections (____1 to 999999)
yy         Year (00 to 99)
mo         Month (01 to 12)
dd         Day (01 to 31)
hh         Hour (00 to 23)
mi         Minute (00 to 59)
ss         Second (00 to 59)

           The year/month/day/hour/minute/second will contain the
           time at which the last data of the block were acquired.
k          Data attributes
           * : Internal memory block being sampled
           + : Internal memory block being overacquired
           (Space) : Fixed block
           If the data of the original block are changing when the
           data are put on standby, * or + is output.
llllllllll ID number (_____0 to 999999999)
           • This becomes a numerical value only when the file
           extension is DEV or DDS. This value is specific to
           the data.
           • This parameter will be space if the file extension is
           not DEV or DDS.
_          Space
    
```

Example

```

EA
02
01 DATA0001 DHR      128 99/02/24 20:10:00
02 DATA0002 DHR      128 99/02/24 20:11:00
EN
    
```

User Level

- The FU command is used to output the data.
- User name, user level, and other information are output.

Syntax

EACRLF

p_l_uuu...uCRLF

ENCRLF

p	Physical layer
E	: Ethernet
S	: RS-232 or RS-422A/485
l	User level
A	: Administrator
U	: User
uuu...u	User name (up to 16 characters)
_	Space

Example

EA

E A admin

EN

6.3 Output Format of BINARY Data

This section describes the output format of the BINARY data that is disclosed. For other BINARY data, see “Identifier” on page 6-3.

- Measured/computed data and FIFO data
- Display data
- Event data

The measured and computed data are output as “16-bit signed integer” and “32-bit signed integer,” respectively. These integers can be understood as physical values by adding the decimal point and the unit. The decimal position is obtained using FE command.

Typical Examples to obtain physical values

Binary value (Integer)	Decimal position code	Physical value (Measured/computed value)
10000	0	10000
10000	1	1000.0
10000	2	100.00
10000	3	10.000
10000	4	1.0000

Note

The “CRLF” used in this section denotes carriage return line feed.

Measured/computed data and FIFO data

- The FD command is used to output the measured/computed data.
- The FF command is used to output the FIFO data.
- The ID number of the output format is “1.” See “Identifier” on page 6-3.

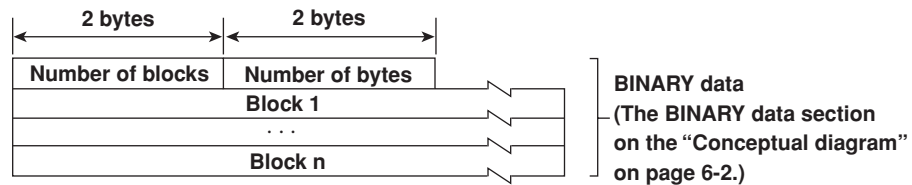

Number of blocks

This is the number of blocks.

Number of bytes

This is the size of one block in bytes.

Block

	1 byte	1 byte	1 byte	1 byte	1 byte	1 byte	2 bytes	1 byte	1 byte	
	Year	Month	Day	Hour	Minute	Second	Millisecond	S/W time*	Flag	
Measured/Computed	Channel	A2A1	A4A3	Measured data						
...						
...						
Measured/Computed	Channel	A2A1	A4A3	Computed data						
...						
...						

4 bytes

* Summer time or Winter time

- **Flag**

The meaning of the flags are given on the table below. The flags are valid during FIFO data output. The flags are undefined for other cases.

Bit	Flag		Meaning of the flag
	0	1	
7	No	Yes	Indicates that the screen snap shot was executed.
6	–	–	
5	–	–	
4	–	–	
3	–	–	
2	No	Yes	Indicates that the decimal position or unit information was changed during measurement.
1	No	Yes	Indicates that the FIFO acquiring interval was changed with the FR command during measurement.
0	No	Yes	Indicates that the internal process took too much time (computation, for example) and that the measurement could not keep up at the specified scan interval.

The flags that have “–” for the flag column are not used. The value is undefined.

- **Block member**

Name	BINARY value
Year	0 to 99
Month	1 to 12
Day	1 to 31
Hour	0 to 23
Minute	0 to 59
Second	0 to 59
Millisecond	0 to 999
Summer, Winter	0, 1
Measurement, Computation	00H : measurement, 80H : computation
Channel	01 to 60
Alarm status*	
A1 (Bit 0 to 3)	
A2 (Bit 4 to 7)	0 to 8
A3 (Bit 0 to 3)	
A4 (Bit 4 to 7)	

* BINARY value 0 to 8 is entered in the upper and lower 4 bits of a byte (8 bits) for the alarm status. The binary values 0 to 8 correspond to H (upper limit alarm), L (lower limit alarm), h (difference upper-limit alarm), l (difference lower-limit alarm), R (upper limit on rate-of-change alarm), r (lower limit on rate-of-change alarm), T (delay upper limit alarm), and t (delay lower limit alarm) as follows:
0: no alarm, 1: H, 2: L, 3: h, 4: l, 5: R, 6: r, 7: T, and 8: t.

Special data value

The measured/computed data take on the following values under special conditions.

Special data value	Measured data	Computed data
+ over	7FFFH	7FFF7FFFH
– over	8001H	8001H8001H
Skip	8002H	8002H8002H
Error	8004H	8004H8004H
Undefined	8005H	8005H8005H

Note

The number of blocks, number of bytes, and measured/computed data are output according to the byte order specified with the BO command.

Display Data

- The MI command is used to output the FIFO data.
- The ID number of the output format is "11." See "Identifier" on page 6-3.

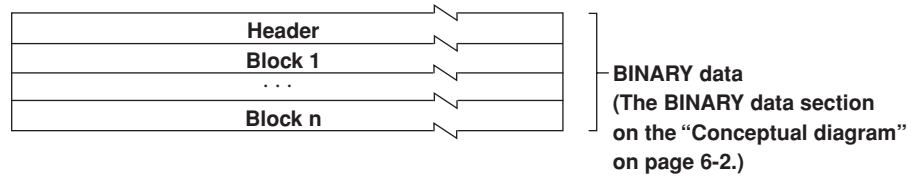

Header

Syntax

```

aaaaaa,ddd,ffffggg,ttttttCRLF
DATE_yy/mo/ddCRLF
TIME_hh:mi:ss.mmmtCRLF
s_kccuuuuu,ppCRLF
.....
s_kccuuuuu,ppCRLF
    
```

```

aaaaaa  Number of data points (6 digits), Matches the number
         of blocks, n, in the above figure.
ddd      Number of channels (3 digits)
ffff     Sampling interval value (4 digits)
ggg      Sampling interval unit (3 characters, left
         justified)
tttttt  Data number of the trigger position (6 digits,
         counting starts with 0.)
         For display data, this value is the number of the
         last display data.
yy       Year (00 to 99)
mo       Month (01 to 12)
dd       Day (01 to 31)
hh       Hour (00 to 23)
mi       Minute (00 to 59)
ss       Second (00 to 59)
mmm      Millisecond (000 to 999)
t        Summer time or winter time
         S : summer time
         (Space) : winter time
s        Data status
         N : Normal
         D : Differential input
k        Channel type
         0 : Measurement channel
         A : Computation channel
cc       Channel number
         01 to 60
uuuuuu  Unit information (6 characters, left-justified)
         mV____ : mV
         V____ : V
         ^C____ : °C
         xxxxxx : (user-defined character string)
pp       Decimal position (00 to 04)
         No decimal (00000) for 00.
         One digit below the decimal (0000.0) for 01.
         Two digits below the decimal (000.00) for 02.
         Three digits below the decimal (00.000) for 03.
         Four digits below the decimal (0.0000) for 04.
_        Space
    
```

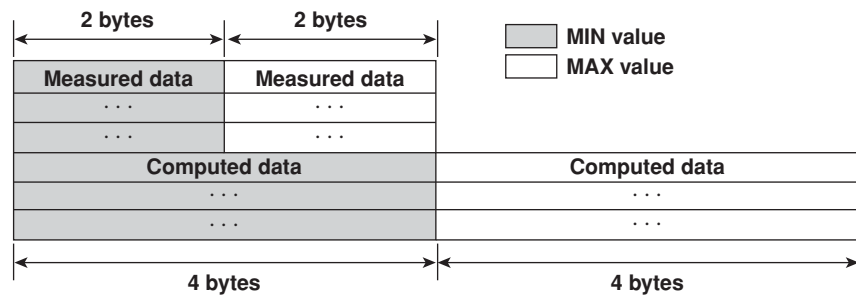
Block**Special data value**

The measured/computed data take on the following values under special conditions.

Special data value	Measured data	Computed data
+ over	7FFFH	7FFF7FFFH
- over	8001H	8001H8001H
Skip	8002H	8002H8002H
Error	8004H	8004H8004H
Undefined	8005H	8005H8005H

Note

The measured/computed data are output according to the byte order specified with the BO command.

Event Data

- The MI command is used to output the FIFO data.
- The ID number of the output format is “12.” See “Identifier” on page 6-3.

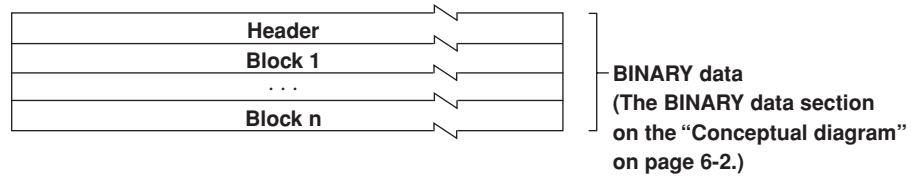

Header

Same as the “Header” for the display data.

Block

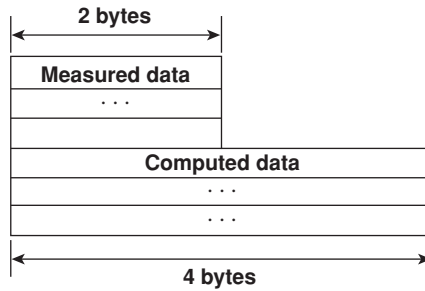

Special data value

The measured/computed data take on the following values under special conditions.

Special data value	Measured data	Computed data
+ over	7FFFH	7FFF7FFFH
– over	8001H	8001H8001H
Skip	8002H	8002H8002H
Error	8004H	8004H8004H
Undefined	8005H	8005H8005H

Note

The measured/computed data are output according to the byte order specified with the BO command.

Manual sampled Data

- The ME or MO command is used to output the data.
- The ID number of the output format is “4.” See “Identifier” on page 6-3.
- For the data format, see the DX100/DX200 User’s Manual (IM04L01A01-01E/IM04L02A01-01E).

Report Data (hourly, daily, weekly, monthly data)

- The ME or MO command is used to output the data.
- The ID number of the output format is “5,” “6,” “7,” and “8” for hourly data, daily data, weekly data, and monthly data, respectively. See “Identifier” on page 6-3.
- For the data format, see the DX100/DX200 User’s Manual (IM04L01A01-01E/IM04L02A01-01E).

6.4 Output Format of Instrument Information

This section describes the instrument information output format of the instrument information server.

Note

The “CRLF” used in this section denotes carriage return line feed.

Response

The parameters of the packet that are returned as a response are lined up according to the following format.

```

ECRLF
(Parameter 1)_=(value of parameter 1)CRLF
(Parameter 2)_=(value of parameter 2)CRLF
.....
ENCRLF

```

- The parameter values are output in the order specified by the command parameter.
- The output order of the parameters when “all” is specified is not constant.
- Even if the same parameters are specified numerous times, only the first occurrence is output.
- Lower-case characters are used for the parameters.
- “_” indicates a space.

The following table shows the parameter types.

Parameter	Output information
all	All information that are output using the parameters below
serial	Serial number
model	Manufacturer, model, and firmware version
host	Host name
ip	IP address

Output Example

Several output examples are indicated below.

Packet Parameter Sent as Commands	Response
The “all” parameter can be used to output all information for parameters serial, model, host, and ip. all	EA serial = 12V636848 model = YOKOGAWA,DX200,1.01 host = DX200-1 ip = 192.168.111.24 EN
Parameters are not case sensitive. ip HoSt	EA ip = 192.168.111.24 host = DX200-1 EN
Even if the same parameters are specified numerous times, only the first occurrence is output. host ip host ip host model	EA host = DX200-1 ip = 192.168.111.24 model = YOKOGAWA,DX200,1.01 EN
Undefined parameters are ignored. (Space)	EA EN

7.2 The Bit Structure of the Status Information

The following four groups of status information are output in response to a status information output request using the IS command. For the output format, see “Status Information” in section 6.2, “Output Format of ASCII Data.”

Status Information 1

Bit	Name	Description
0	A/D conversion complete	Set to “1” when the A/D conversion of the measurement is complete.
1	Medium access complete	Set to “1” when the display, event, manual sampled, report, TLOG, or screen image data file are finished being saved to the external storage medium. Set to “1” when setting data is successfully saved or loaded.
2	Report generation complete	Set to “1” when report generation is complete.
3	Timeout	Set to “1” when the timer expires.
4	–	–
5	–	–
6	–	–
7	–	–

Status Information 2

Bit	Name	Description
0	Measurement drop	Set to “1” when the measurement process could not keep up.
1	Decimal/unit information change	Set to “1” when the decimal/unit information is changed.
2	Command error	Set to “1” when there is a command syntax error.
3	Execution error	Set to “1” when an error occurs during command execution.
4	–	–
5	–	–
6	–	–
7	–	–

Status Information 3

Bit	Name	Description
0	–	–
1	–	–
2	Memory end	Set to “1” when the free space in the internal memory or the external storage medium is low (see section 1.8 of the DX100/DX200 User’s Manual).
3	–	–
4	–	–
5	–	–
6	–	–
7	–	–

Status Information 4

Bit	Name	Description
0	Basic setting	Set to "1" during basic setting mode.
1	Memory sampling	Set to "1" while data are being acquired into the internal memory.
2	Computing	Set to "1" only when computation is executed.
3	Alarm generating	Set to "1" while the alarm is occurring.
4	Accessing medium	Set to "1" while the display, event, manual sampled, report, TLOG, or screen image data file are being saved to the external storage medium.
5	Activating e-mail	Set to "1" while the e-mail function is engaged.
6	—	—
7	—	—

Appendix 1 ASCII Character Codes

		Upper 4 bits															
		0	1	2	3	4	5	6	7	8	9	A	B	C	D	E	F
Lower 4 bits	0			SP	0	@	P	p									
	1				1	A	Q	a	q								
	2				2	B	R	b	r								
	3			#	3	C	S	c	s								
	4				4	D	T	d	t								
	5			%	5	E	U	e	u								
	6			&	6	F	V	f	v								
	7				7	G	W	g	w								
	8			(8	H	X	h	x								
	9)	9	I	Y	i	y								
	A	LF		*	:	J	Z	j	z								
	B		ESC	+		K		k									
	C					L		l									
	D	CR		-		M		m									
	E			.		N	°	n									
	F			/		O	—	o									

Appendix 2 Output Flow of Internal Memory Data

Display Data Example

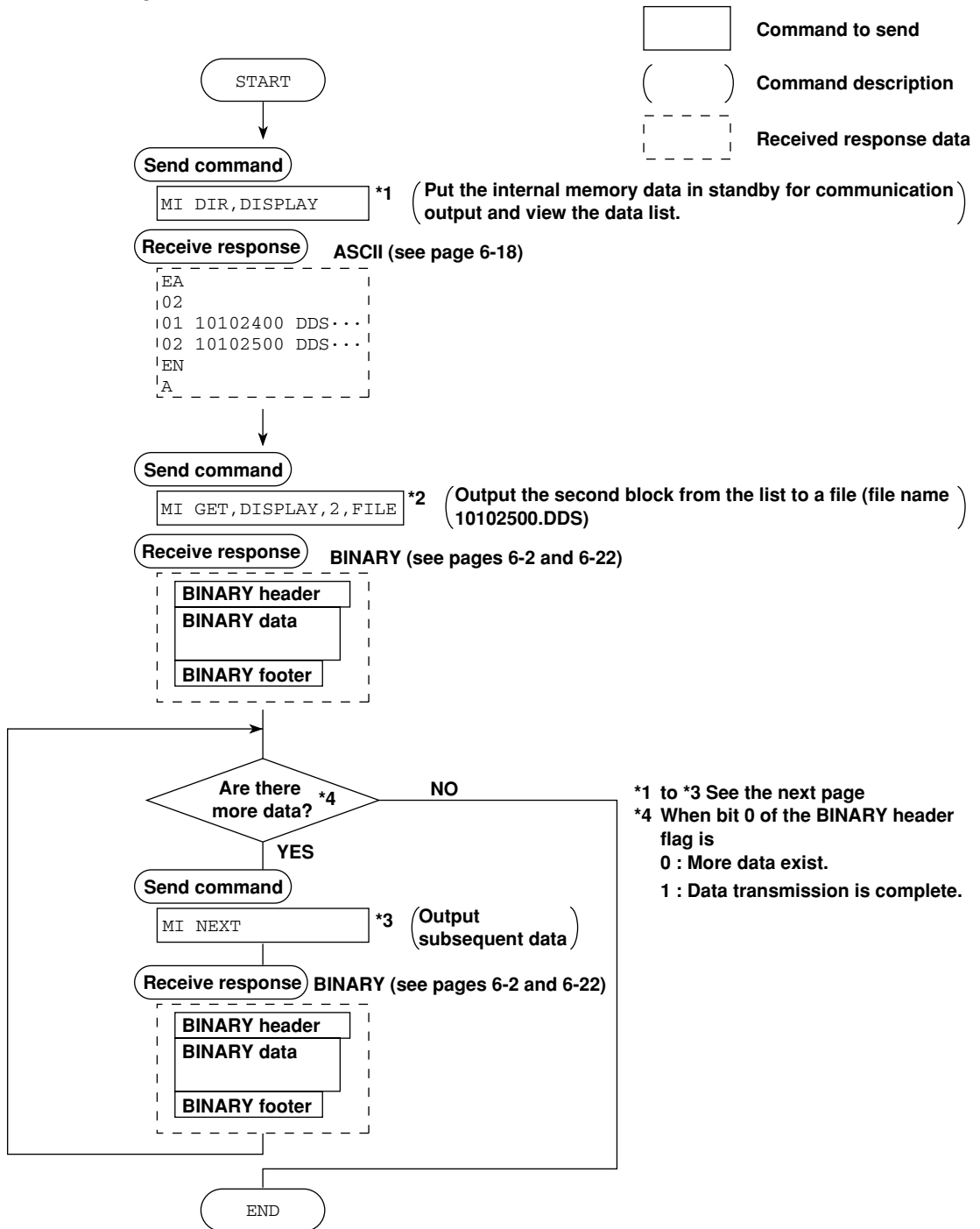

Event data (Set *1, *2, and *3 in the previous figure to the following commands)

- *1 : MI DIR, EVENT Output the list.
- *2 : MI GET, EVENT, 2, FILE Output the data of the second block to a file.
- *3 : MI NEXT If there are subsequent data, output the data.

Manual sampled data (Set *1 and *2 in the previous figure to the following commands)

- *1 : MO DIR, MANUAL
 - *2 : MO GET, MANUAL, 2
- Since manual sampled data can be transmitted in one session, *3 is not necessary.

Report data (Set *1 and *2 in the previous figure to the following commands)

- *1 : MO DIR, REPORT
 - *2 : MO GET, REPORT, 2
- Since report data can be transmitted in one session, *3 is not necessary.

TLOG data (Set *1, *2, and *3 in the previous figure to the following commands)

- *1 : MO DIR, TLOG
- *2 : MO GET, TLOG, 2
- *3 : MO NEXT

Appendix 3 Output Flow of the File or the File List in the External Storage Medium

Example in which the file 10101000.DDS in the DATA0 directory is output

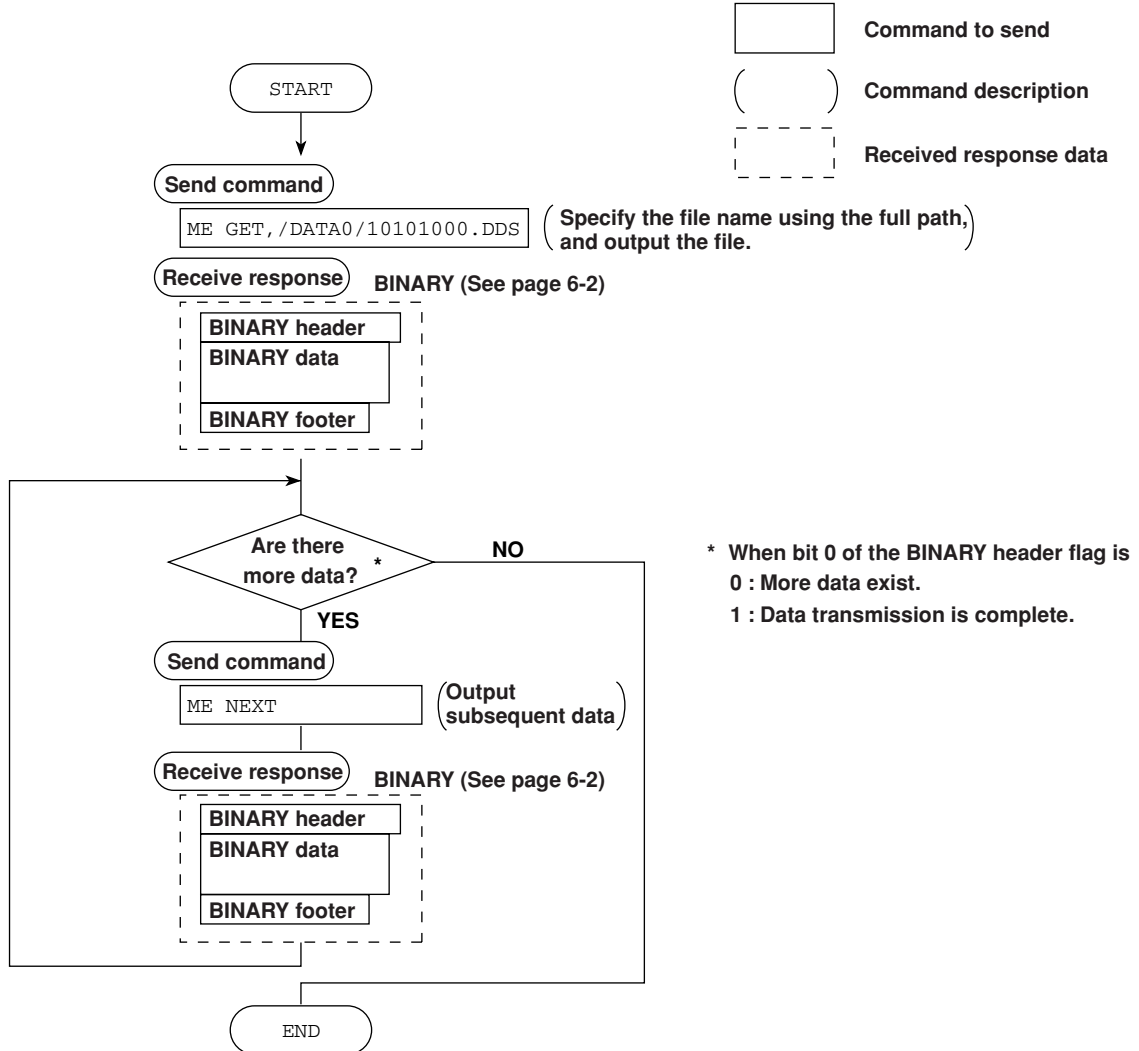

Example in which the file list belonging to directory DATA0 is output 10 files at a time

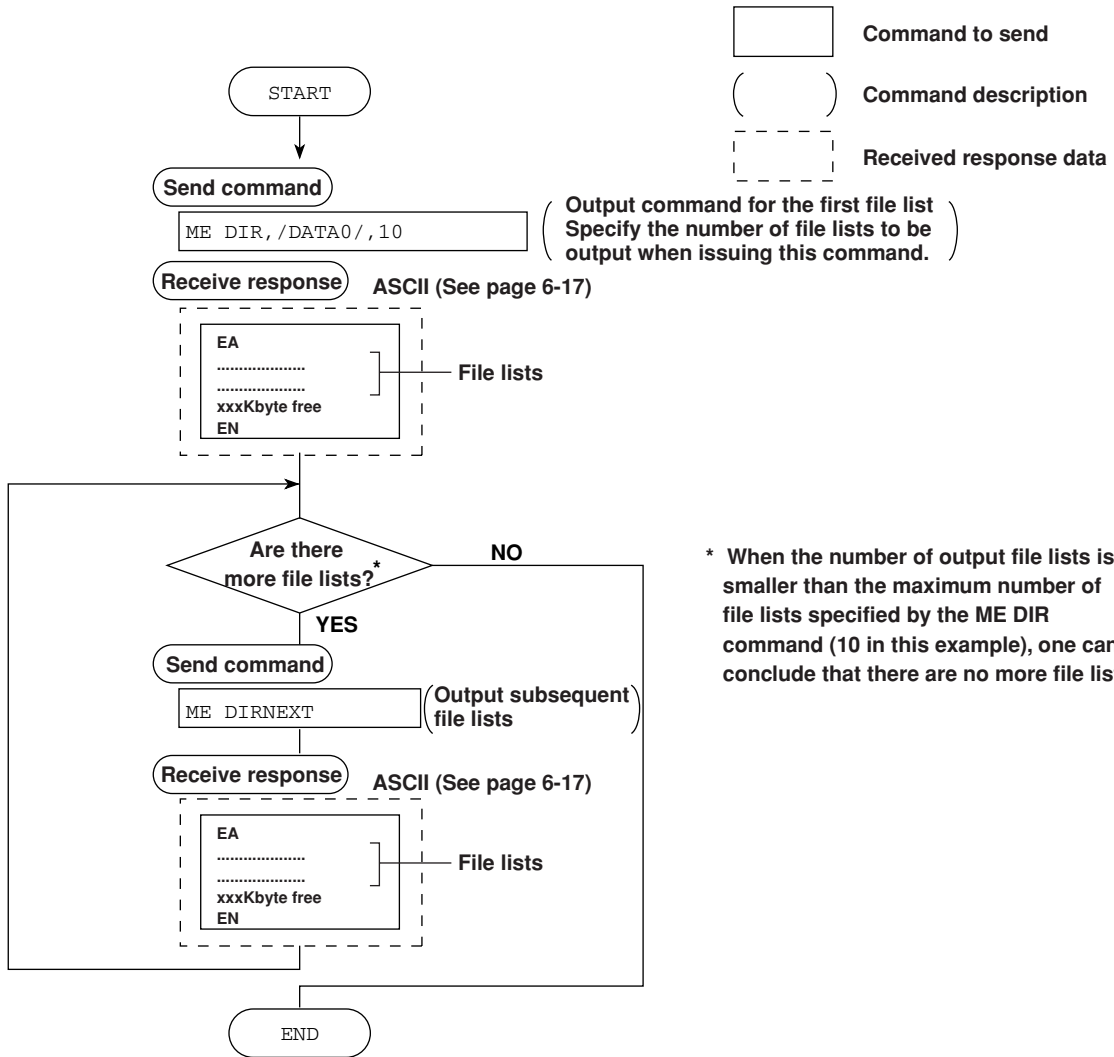

* When the number of output file lists is smaller than the maximum number of file lists specified by the ME DIR command (10 in this example), one can conclude that there are no more file lists.

Appendix 4 Output Flow of FIFO Data

Overview of the FIFO Buffer

The DX has a dedicated internal memory for outputting measured/computed data. This memory is structured as a FIFO (First-In-First-Out). Measured/computed data are constantly acquired to the internal memory at the specified acquiring interval (FIFO acquiring interval, set with the FR command). By using this function, it is possible to read measured/computed data that have been saved at the specified intervals regardless of the frequency at which the PC periodically reads the measured/computed data.

The following example shows the case when the acquiring interval is 1 s and the capacity of the FIFO memory is for 8 intervals.

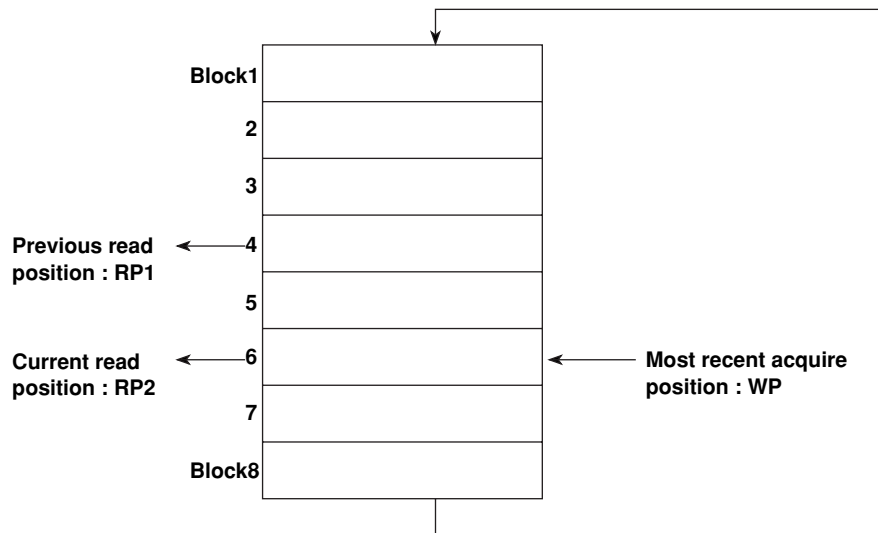

- Acquiring of the measured/computed data
 - The measured/computed data are acquired to the internal memory at 1 s intervals.
 - Measured/computed data are acquired to blocks 1 through 8 in order. After acquiring to block 8, the next acquiring operation returns to block 1.
- Reading the measured/computed data (FF GET command)
 - Outputs the data from the next to the previous read position (RP1) to the most recent acquire position (WP).
 - In this example, more than 2 s has elapsed from the previous read operation. Therefore, data in blocks 5 and 6 are output.
- Reading the measured/computed data (FF GETNEW command)
 - Output the specified number of blocks of FIFO data back starting from the recent acquire position (WP).
 - In this example, if you specify the number of blocks to “5,” data in blocks 2 to 6 are output.

The capacity of the FIFO memory (FIFO buffer data length) that is allocated varies depending on the model.

DX102/DX104/DX204/DX208: 240 intervals (30 s at a acquiring interval of 125 ms)

DX106/DX112/DX210/DX220/DX230: 60 intervals (60 s at a acquiring interval of 1 s)

Example in which the FIFO acquiring interval on the DX230 is set to 1 s and the measured/computed data from CH1 to CH60 are continuously output using the FIFO function

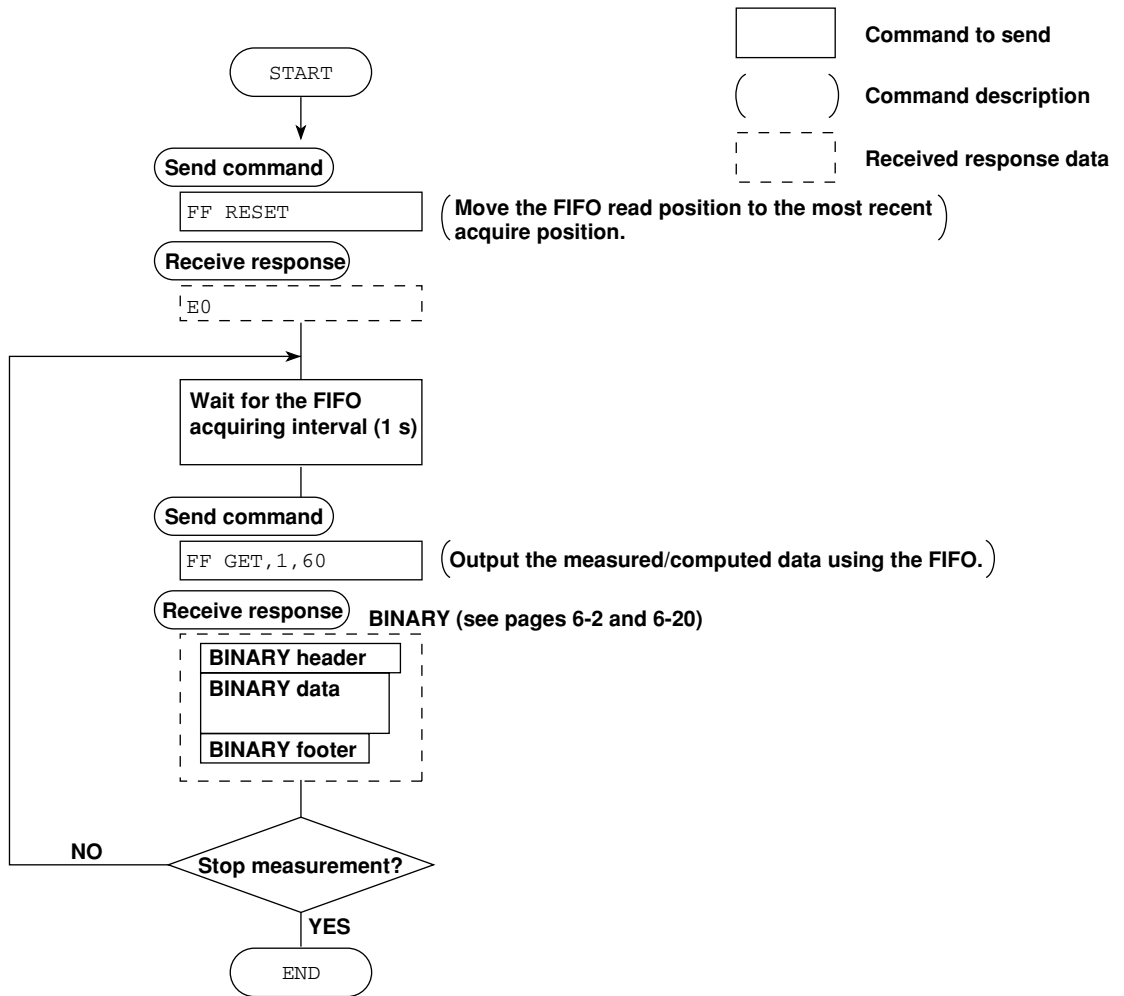

Note

- The FIFO acquiring interval must be set using the FR command beforehand.
- The FIFO acquiring interval applies to both serial and Ethernet communications.

Appendix 5 Data Dropout (Modbus Master)

If the DX does not have received the response from the slave device corresponding to the command it transmitted until the time for the next command transmission, data dropout occurs. Take appropriate measures referring to the figures below.

1. When slave device takes time to respond

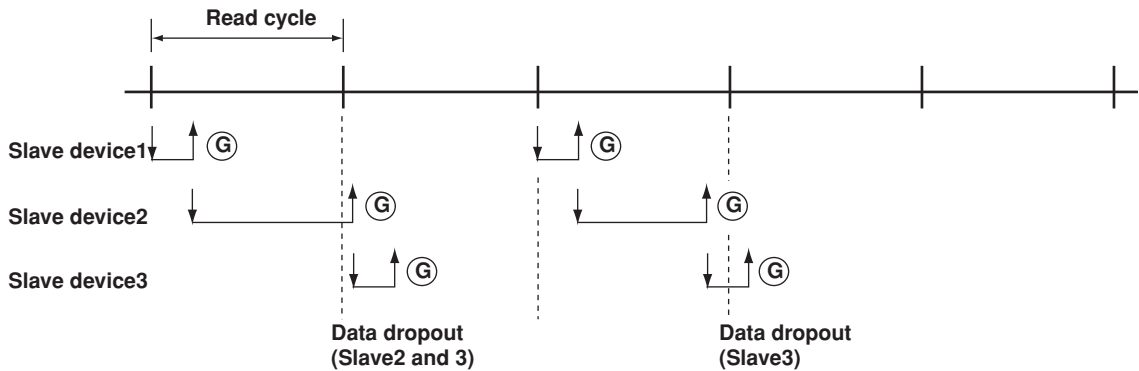

2. When slave device does not respond

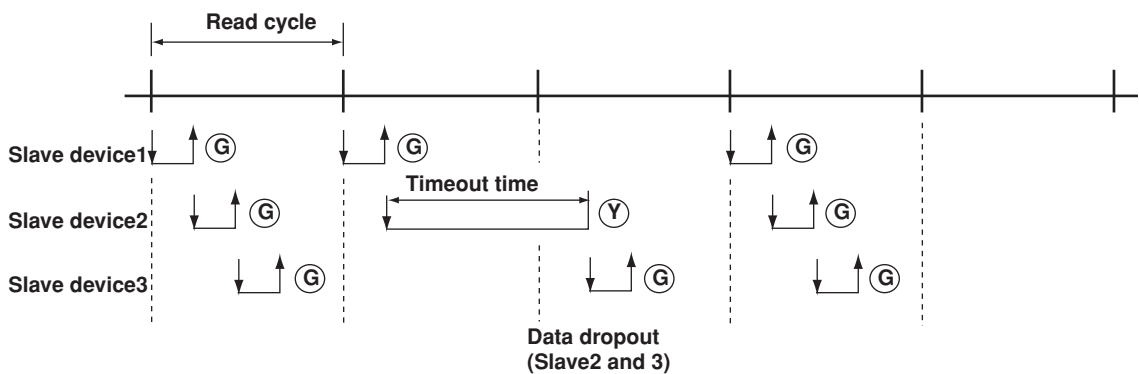

3. When slave device is disconnected (Number of retrials is set to "1")

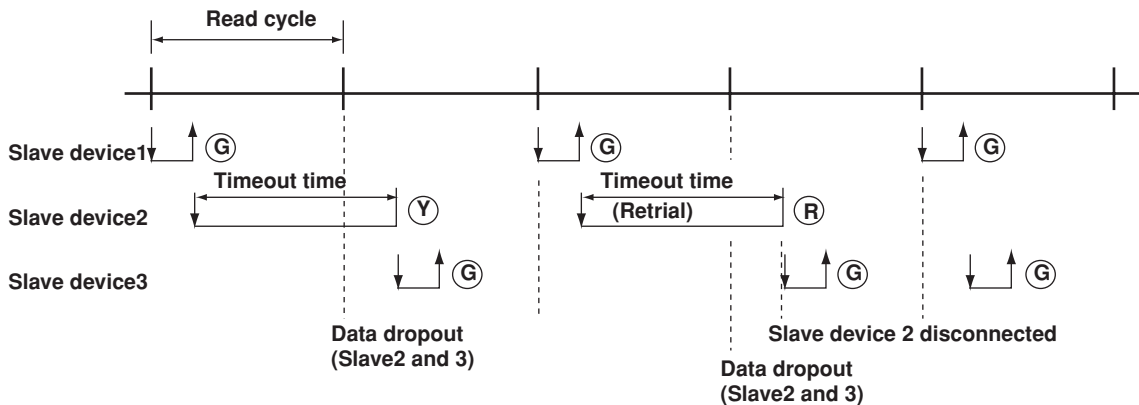

ⓐ ⓑ ⓓ : Status lamp, G: Green, Y: Yellow, R: Red

↓ : Command from the DX

↑ : Response from slave device

Appendix 6 A List of Error Messages

The list of error codes and messages is given below.

Errors Related to Parameter Settings

• Setting Errors

Code	Message	Explanation/Countermeasures/Ref. section
1	System error.	Contact your nearest YOKOGAWA dealer.
2	Incorrect date or time setting.	See section 3.7.* ¹
3	A disabled channel is selected.	See sections 5.4, 5.6, and 5.8.
4	Incorrect function parameter.	See sections 5.4 to 5.11.
5	The input numerical value exceeds the set range.	Enter a proper value.
6	Incorrect input character string.	Enter a proper character string.
7	Too many characters.	Enter specified number of characters.
8	Incorrect input mode.	See section 5.4.
9	Incorrect input range code.	See section 5.4.
21	Cannot set an alarm for a skipped channel.	See section 5.4.
22	The upper and lower span limits are equal.	See sections 5.1 to 5.7.* ¹
23	The upper and lower scale limits are equal.	See sections 5.5 and 5.6.* ¹
30	The partial boundary value exceeds the range of the span.	See section 7.11.* ¹
31	Partial expansion display is set ON for a SKIPPED channel.	See section 5.4.
35	The upper and lower limits of the display band are equal.	See section 7.9.* ¹
36	The lower limit of the display band is greater than the upper limit.	See section 7.9.* ¹
37	The display band is narrower than 4% of the entire display.	See section 7.9.* ¹
40	Incorrect group set character string.	See section 7.6.* ¹
41	There is no specified input channel.	See sections 5.4, 5.6, and 5.8.
42	Exceeded the number of channels which can be set.	See sections 5.4, 5.6, and 5.8.
43	A channel number cannot repeat in a group.	See section 7.6.* ¹
45	There is no character string saved in the clipboard.	Copy a character string to the clipboard.
46	The character string saved in the clipboard is too long.	Paste a character string with the specified number of characters.
61	There is no channel specified by the MATH expression.	See section 11.4.* ¹
62	MATH expression grammar is incorrect.	See section 11.2.* ¹
63	MATH expression sequence is incorrect.	See section 11.2.* ¹
64	MATH upper and lower span values are equal.	See section 11.4.* ¹
70	The range of the MATH constant is exceeded.	See section 11.4.* ¹
71	Set range of the MATH constant is exceeded.	See section 11.6.* ¹
81	All space or 'quit' string cannot be specified.	See section 10.6.* ¹
83	Duplicate used combination of user ID and password.	See section 10.6* ¹ (when /BT1 is equipped).
85	The login password is incorrect.	See section 10.5.* ¹
86	The key-lock release password is incorrect.	See section 10.3.* ¹
87	This key is locked.	See section 10.3.* ¹
88	This function is locked.	See section 10.3.* ¹
89	Press [FUNC] key to login.	See section 10.5.* ¹
90	No permission to enter to the SETUP mode.	See sections 10.5 and 10.6.* ¹
91	Password is incorrect.	See sections 10.3 and 10.5.* ¹
92	Press [ESC] key to change to the operation mode.	Press the ESC key.
93	String including space or all space cannot be specified.	Spaces are not allowed in the Web user name and password.
94	More than one address cannot be specified.	Multiple addresses cannot be specified. Only a single sender is allowed.

Appendix 6 A List of Error Messages

Code	Message	Explanation/Countermeasures/Ref. section
100	IP address doesn't belong to class A, B, or C.	See section 5.6.
101	The result of the masked IP address is all 0s or 1s.	See section 5.6.
102	SUBNET mask is incorrect.	See section 5.6.
103	The net part of default gateway is not equal to that of IP address.	See section 5.6.
104	FTP client failed because the memory mode is 'manual'.	See section 5.6.

*1 See the DX100/DX200 User's Manual (IM04L01A01-01E, IM04L02A01-01E).

• Execution Errors

Code	Message	Explanation/Countermeasures/Ref. section
150	This action is not possible because sampling is in progress.	See sections 8.5 and 8.6.* ¹
151	This action is not possible during sampling or calculating.	See sections 8.5, 8.6, and 11.3.* ¹
152	This action is not possible because saving is in progress.	Wait till the saving ends.
153	This action is not possible because formatting is in progress.	Wait till the formatting ends.
155	The message is not written while sampling is stopped.	See sections 8.5 and 8.6.* ¹
160	Cannot load the specified data. Change the memory setting.	See sections 4.5, 9.3, and 9.4.* ¹

*1 See the DX100/DX200 User's Manual (IM04L01A01-01E, IM04L02A01-01E).

Operation Errors

• Errors related to external storage medium

Code	Message	Explanation/Countermeasures/Ref. section
200	Operation aborted because an error was found in media.	Check the storage medium.
201	Not enough free space on media.	Use another storage medium.
202	Media is read-only.	Release the write protection.
210	Media has not been inserted.	Insert a storage medium into the drive.
211	Media is damaged or not formatted.	Use another storage medium or carry out formatting.
212	Format error.	Try formatting again or use another storage medium.
213	The file is read-only.	Access to other files or make the file write-enable.
214	There is no file or directory.	See section 5.8.
215	Exceeded the allowable number of files.	Delete files or change storage medium.
216	The file or directory name is incorrect.	See sections 8.9 and 9.1.* ¹
217	Unknown file type.	Access to other files.
218	Directory exists. Delete the directory or change directory name.	See section 8.9.* ¹
219	Invalid file or directory operation.	Cannot handle files and directories in the 2nd and deeper layers.
220	The file is already in use. Try again later.	Wait till file is free.
230	There is no setting file.	Access to other files.
231	Abnormal setting exists in file.	Access to other files.

*1 See the DX100/DX200 User's Manual (IM04L01A01-01E, IM04L02A01-01E).

• **Errors related to historical trend**

Code	Message	Explanation/Countermeasures/Ref. section
232	There is no available data.	This message may appear when recalling historical trend. Access to other files.
233	The specified historical data do not exist.	This message may appear when recalling historical trend. See section 4.5.
234	The specified channel is not assigned to the display group.	This message may appear when switching to trend or bar graph from overview. See sections 4.4 and 7.6.

• **Errors related to e-mail and Web server**

Code	Message	Explanation/Countermeasures/Ref. section
260	IP address is not set or ethernet function is not available.	The IP address is not specified. Check the IP address.
261	SMTP server is not found.	Occurs when the SMTP server is specified by name. • Check the DNS setting. • Check the SMTP server name.
262	Cannot initiate E-mail transmission.	• The host name of the DX is not correct. Check the host name. • The port number for SMTP server is not correct. Check the port number.
263	Sender's address rejected by the server.	Check the sender's address.
264	Some recipients' addresses are invalid.	Check the recipient's address.
265	SMTP protocol error.	May occur if a network failure (cable problems, duplicate addresses, network device failure, and so on) occurs in the middle of the e-mail transmission.
266	Ethernet cable is not connected.	Check the cable connection.
267	Could not connect to SMTP server.	• Check to see that the SMTP server is connected to the network. • If the SMTP server name is specified using an IP address, check to see that the IP address is correct.
268	E-mail transmission request failed.	Contact your nearest YOKOGAWA dealer.
269	E-mail transfer error.	May occur if a network failure (cable problems, duplicate addresses, network device failure, and so on) occurs in the middle of the e-mail transmission.
275	The current image cannot be output to the Web.	The setup screen cannot be output to the Web. This message is displayed on the Web screen.
276	Image data currently being created. Unable to perform key operation.	Try again a little later. This message is displayed on the Web screen.
277	Could not output screen to Web.	Failed to create the image. This message is displayed on the Web screen.

Appendix 6 A List of Error Messages

• Errors related to FTP client

For information regarding the FTP client function of the DX100/DX200, see the DX100/DX200 Communication Interface User's Manual (IM04L02A01-17E).

Code	Message
280	<p>IP address is not set or FTP function is not available. Further details are provided by the character string that appears after error code 280.</p> <hr/> <p>Character String and Details</p> <hr/> <p>HOSTADDR The DX's IP address has not been specified. Check the IP address.</p> <p>DORMANT Internal processing error.*1</p> <p>LINK Data link is disconnected. Check the cable connection.</p>
281	<p>FTP mail box operation error. Further details are provided by the character string that appears after error code 281.</p> <hr/> <p>Character String and Details</p> <hr/> <p>MAIL Internal processing error.*1</p> <p>STATUS Internal processing error.*1</p> <p>TIMEOUT Internal processing error.*1</p> <p>PRIORITY Internal processing error.*1</p> <p>NVRAM Internal processing error.*1</p>
282	<p>FTP control connection error. Further details are provided by the character string that appears after error code 282.</p> <hr/> <p>Character String and Details</p> <hr/> <p>HOSTNAME Failed the DNS lookup (search the IP address corresponding to the host name). Check the DNS setting and the destination host name.</p> <p>TCPIP Internal processing error.*1</p> <p>UNREACH Failed to connect to a control connection server. Check the address setting and that the server is running.</p> <p>OOBINLINE Internal processing error.*1</p> <p>NAME Internal processing error.*1</p> <p>CTRL The control connection does not exist. Check that the server does not drop the connection and that it responds within the proper time period.</p> <p>IAC Failed to respond in the TELNET sequence. Check that the server does not drop the connection and that it responds within the proper time period.</p> <p>ECHO Failed to transmit data on the control connection. Check that the server does not drop the connection and that it responds within the proper time period.</p> <p>REPLY Failed to receive data on the control connection. Check that the server does not drop the connection and that it responds within the proper time period.</p> <p>SERVER The server is not in a condition to provide the service. Check that the server is in a condition in which service can be provided.</p>

Code Message

283 FTP command was not accepted.
 Further details are provided by the character string that appears after error code 283.

Character String and Details

USER

Failed user name verification.
 Check the user name setting.

PASS

Failed password verification
 Check the password setting.

ACCT

Failed account verification.
 Check the account setting.

TYPE

Failed to change the transfer type.
 Check that the server supports the binary transfer mode.

CWD

Failed to change the directory.
 Check the initial path setting.

PORT

Failed to set the transfer connection.
 Check that the security function is disabled.

PASV

Failed to set the transfer connection.
 Check that the server supports PASV commands.

SCAN

Failed to read the transfer connection settings.
 Check that proper response to the PASV command is received from the server.

284 FTP transfer setting error.
 Further details are provided by the character string that appears after error code 284.

Character String and Details

MODE

Internal processing error.*1

LOCAL

Internal processing error.*1

REMOTE

The destination file name is not correct.
 Check that you have the authority to create or overwrite files.

ABORT

File transfer abort was requested by the server.
 Check the server for the reason for the abort request.

Appendix 6 A List of Error Messages

Code	Message
285	<p>FTP data connection error.</p> <p>Further details are provided by the character string that appears after error code 285.</p> <p>Character String and Details</p> <p>SOCKET Failed to create a socket for the transfer connection.*²</p> <p>BIND Failed the transfer connection command.*²</p> <p>CONNECT Failed the transfer connection.*²</p> <p>LISTEN Failed the transfer connection reception.*²</p> <p>ACCEPT Failed to accept the transfer connection.*²</p> <p>SOCKNAME Internal processing error.*²</p> <p>RECV Failed to receive data over the transfer connection.*²</p> <p>SEND Failed to send data over the transfer connection.*²</p>
286	<p>FTP file transfer error.</p> <p>Further details are provided by the character string that appears after error code 286.</p> <p>Character String and Details</p> <p>READ Internal processing error.*¹</p> <p>WRITE Internal processing error.*¹</p>

*¹ Contact your nearest YOKOGAWA dealer.

*² These errors may occur if the network experiences trouble during the data transmission (bad cable connection, duplicate addresses, network equipment failure).

Note

The FTP client function on the DX100/DX200 has a timer function that drops the connection if there is no data transfer for two minutes. If the server does not respond within this time period, the transfer fails.

Communication Errors

• Errors during Setting and Basic Setting Modes, Output Communication Command Execution, and Setup Data Loading

Code	Message
300	Command is too long.
301	Too many number of commands delimited with ';'.
302	This command has not been defined.
303	Data request command can not be enumerated with sub-delimiter.
350	Command is not permitted to the current user level.
351	This command cannot be specified in the current mode.
352	The option is not installed.
353	This command cannot be specified in the current setting.
354	This command is not available during sampling or calculating.

- **Memory Access Errors during Setting and Basic Setting Modes and Output Communication Command Execution**

An English error message is returned via the communication interface. It is not displayed on the screen.

Code	Message
360	Output interface must be chosen from Ethernet or RS by using 'XO' command.
361	The memory data is not saved for the communication output.
362	There are no data to send 'NEXT' or 'RESEND'.
363	All data have already been transferred.

- **Maintenance and Test Communication Command Errors**

An English error message is returned via the communication interface. It is not displayed on the screen.

Code	Message
390	Command error.
391	Delimiter error.
392	Parameter error.
393	No permission.
394	No such connection.
395	Use 'quit' to close this connection.
396	Failed to disconnect.
397	No TCP control block.

- **Other Communication Errors**

An English error message is returned via the communication interface. It is not displayed on the screen.

Code	Message
400	Input username.
401	Input password.
402	Select username from 'admin' or 'user'.
403	Login incorrect, try again!
404	No more login at the specified level is acceptable.
410	Login successful. (The special user level)
411	Login successful. (The general user level)
420	Connection has been lost.
421	The number of simultaneous connection has been exceeded.
422	Communication has timed-out.

Appendix 7 Login Process

You log into the DX from your PC to use the functionality of the setting/measurement server and the maintenance/test server via the Ethernet interface. If you complete the process successfully up to login complete in the following figure, the commands in chapter 5 become functional.

When using the Ethernet login function of the DX

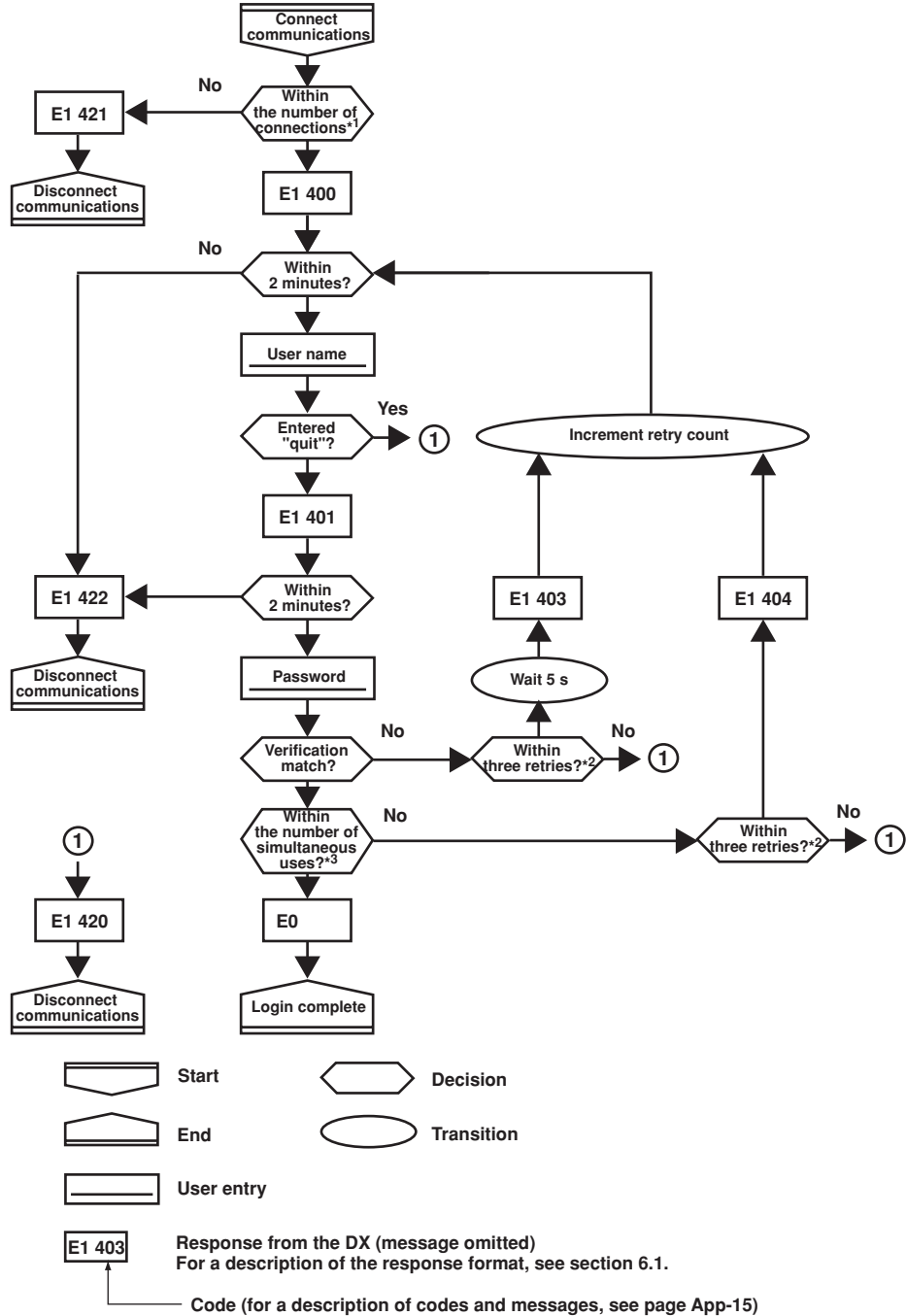

- *1 Connections cannot exceed the maximum number of connections (see section 2.1).
- *2 If you attempt to log in using a wrong password four consecutive times, the communication is dropped (the number of login retries is three).
- *3 If you attempt to log in causing the number of simultaneous use at the Administrator or User level to be exceeded (see section 2.1) four consecutive times, the communication is dropped (even if the password is correct).

When not using the Ethernet login function of the DX

Login as “admin” or “user.”

- You can log into the DX as an administrator by accessing the DX using the user name “admin.”
- You can log into the DX as a user by accessing the DX using the user name “user.”

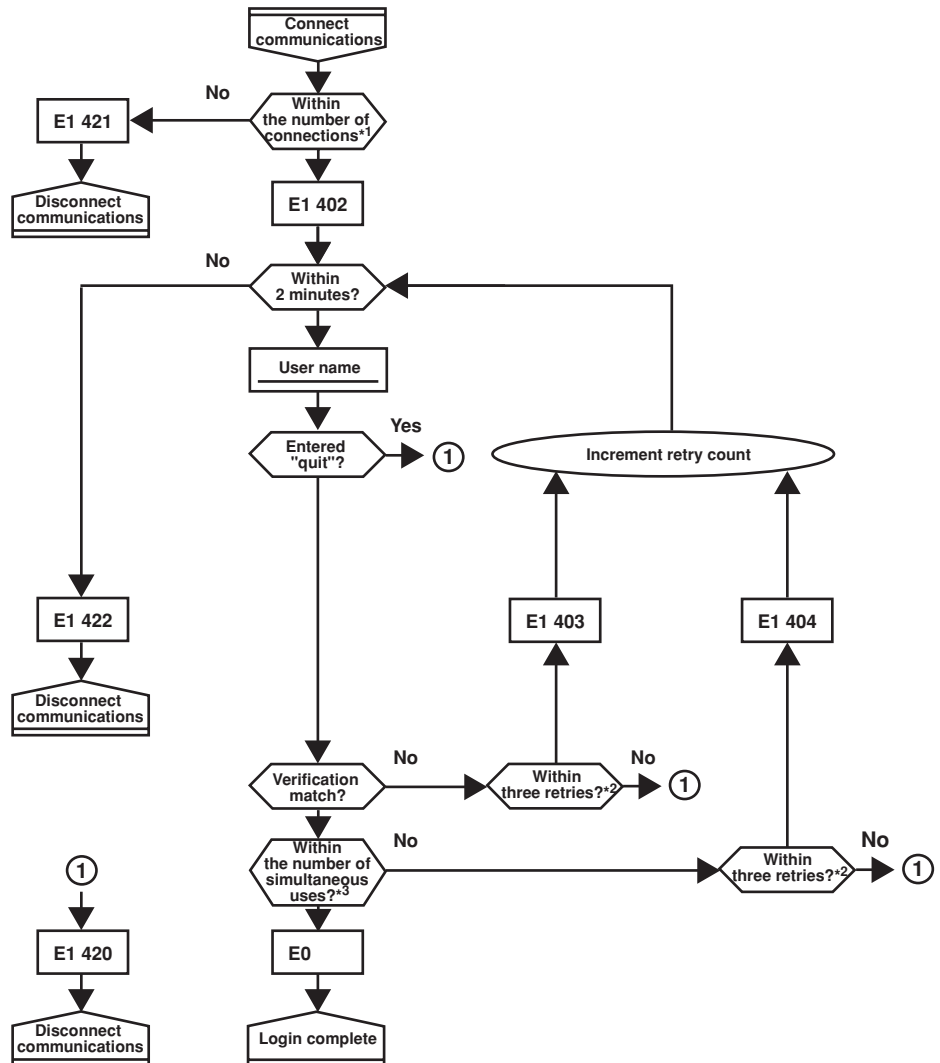

Index

A

access control	2-27
account	2-11
address	3-10, 4-4, 4-6
administrator	1-5, 2-17
affirmative response	6-1
arrow key	iv
ASCII character code	App-1
authority	1-5
automatic file transfer	1-4
automatic transfer of data files	2-10

B

basic setting command	5-4, 5-20
basic setting mode	5-4
baud rate	3-10, 4-4
BINARY data section	6-2
BINARY data type	6-3
BINARY footer section	6-2
BINARY header section	6-2
bit structure	3-9
bit structure of the status information	7-2
block (display data)	6-23
block (event data)	6-24
block (measured/computed/FIFO data)	6-20
block member	6-21
BO flag	6-3
browser	2-31

C

cable	3-5
cable connection procedure	3-5
calculating the sum value	6-4
canceling operation	vii
carriage return code	App-1
character/number input key	iv
checking the connection status	2-9
command	
AK	5-18
all	5-34
BA	5-16
BB	5-17
BC	5-17
BD	5-17
BO	5-29
CC	5-29
close	5-33
CM	5-20
con	5-33
CS	5-29
DS	5-19
EM	5-20
ESC C	5-32
ESC O	5-32
eth	5-33
EV	5-19
FC	5-29
FD	5-30
FE	5-29
FF	5-30

FL	5-30
FR	5-16
FU	5-31
help	5-33
host	5-34
IF	5-29
ip	5-34
IS	5-31
KE	5-20
LI	5-19
LO	5-19
ME	5-31
MI	5-31
MO	5-32
model	5-34
MS	5-19
net	5-33
PS	5-18
quit	5-34
RM	5-24
RO	5-23
SA	5-10
SB	5-13
SC	5-14
SD	5-11
SE	5-13
serial	5-34
SF	5-14
SG	5-13
SH	5-13
SI	5-15
SJ	5-15
SK	5-15
SL	5-12
SO	5-10
SP	5-12
SQ	5-14
SR	5-9
SS	5-16
ST	5-12
SU	5-15
SV	5-13
SW	5-11
SX	5-12
SY	5-14
SZ	5-11
TL	5-19
UD	5-17
XB	5-21
XE	5-24
XG	5-25
XH	5-24
XI	5-21
XJ	5-21
XM	5-21
XO	5-24
XP	5-25
XQ	5-23
XR	5-22
XS	5-21
XT	5-21
XU	5-22
XV	5-21
YA	5-25

Index

YC 5-26
YG 5-27
YI 5-26
YK 5-25
YL 5-27
YM 5-27
YN 5-25
YO 5-26
YQ 5-26
YS 5-26
YT 5-26
YU 5-27
YV 5-28
YW 5-28
YX 5-28
command (Modbus master) 4-7
command name 5-1
command syntax 5-1
command-response 6-1
communication condition 4-13
communication distance 3-1
communication function 1-1
communication log 2-22
communication timeout 1-5, 2-18
conceptual diagram (BINARY) 6-2
configuring the Ethernet interface 2-3
confirming operation vi
confirming the connection status 1-7
connecting the Ethernet interface 2-2
connection status 1-7
connector pin arrangement (RS-232) 3-2
converter 3-8
CR + LF 5-2
CS-RS 3-4

D

data dropout (Modbus master) 4-13, App-8
data length 3-10
data length (BINARY output) 6-2
data reception control 3-3
data sum 6-2
data transmission control 3-3
default gateway 2-3
delimiter 5-2
DISP/ENTER key iv
DNS 2-3
DNS server 2-3
domain name 2-3
domain suffix 2-4

E

e-mail log 2-23
e-mail message 2-48
e-mail transmission 1-6
e-mail transmission test 2-47
END flag 6-3
error log 2-22
error message App-9
ESC key iv
escape code App-1
Ethernet interface connector v
execution mode 5-3
explanation of the function 1-2

F

FIFO buffer App-6
file transfer destination directory 2-14
filter 7-1
flag 6-3
flag (FIFO) 6-21
FLOAT_B 4-9
FLOAT_L 4-9
flow of operation vi
front panel iv
FTP client 1-4
FTP connection 2-10
FTP log 2-22
FTP server 1-3
FTP server name 2-11
FTP test 1-4, 2-16
FUNC key iv

G

granting access authority 1-5

H

handshaking 3-3, 3-10
header 6-22, 6-24
header sum 6-2
hold register 4-2
host name 2-3

I

identifier (BINARY data) 6-3
initial path 2-11
input range parameter 5-7
input register 4-2
instrument information output command 5-6, 5-34
instrument information server 1-4
INT16 4-8
INT32_B 4-8
INT32_L 4-8
IP address 2-3
ITU-T 3-2

K

keepalive 1-7, 2-18

L

LF 5-2
line feed code App-1
list of commands 5-3
login 1-5, 2-17
login name 2-11
login process App-16

M

maintenance/test command 5-6, 5-33
maintenance/test server 1-3
master 4-1
maximum number of connections 2-1
MENU key iv
Modbus error response 4-3

Modbus master	1-2
Modbus protocol	4-4
Modbus protocol specification	4-1, 4-7
Modbus slave	1-2
MODBUS STATUS screen	4-13
monitor page	2-26
monitor page (contents)	2-31
multiple negative responses	6-1

N

name of part	iv
negative response	6-1
Normal protocol	3-10
number of bytes	6-20
number of simultaneous uses	2-1

O

OFF-OFF	3-3
operation mode	5-4
operator page	2-26
output command	5-6
output command (control)	5-29
output command (RS-422-A/485 dedicated commands) ..	5-32
output command (RS-422A/485 dedicated commands) ...	5-32
output command (setup, measured, and computed)	5-29
output flow of FIFO data	App-6
output flow of internal memory data	App-2
output flow of the file	App-4
output flow of the file list	App-5
output format (alarm summary)	6-15
output format (communication log)	6-9
output format (data list)	6-18
output format (decimal position/unit information)	6-7
output format (display BINARY data)	6-22
output format (e-mail log)	6-14
output format (event BINARY data)	6-24
output format (FIFO BINARY data)	6-20
output format (file list)	6-17
output format (FTP log)	6-11
output format (key login log)	6-12
output format (manual sampled data)	6-24
output format (measured/computed BINARY data)	6-20
output format (measured/computed data)	6-8
output format (message summary)	6-16
output format (operation error log)	6-12
output format (report data)	6-24
output format (setting data/basic setting data)	6-6
output format (status information)	6-16
output format (user level)	6-19
output format (web operation log)	6-13
output format of ASCII data	6-6
output format of BINARY data	6-20
output format of instrument information	6-25

P

parameter	5-1
parameter (instrument information)	6-25
parity check	3-10, 4-4
password	2-11, 2-17, 2-26, 2-27
PASV mode	2-11
pin arrangement (RS-422A/485)	3-5
port number	2-1, 2-11, 2-38
primary	2-3, 2-10
protocol	1-1

Q

query	5-2
-------------	-----

R

read cycle	4-7
rear panel	v
receive buffer	3-9
recipient	2-38
refreshing the monitor page	2-32
register assignments	4-2
response	5-2
response (instrument information)	6-25
response syntax	6-1
resuming command transmission	4-13
retrials	4-7
RS-232 interface connector	v
RS-232 interface specification	3-1
RS-232 standard	3-2
RS-422-A/485 interface terminal	v
RS-422A/485 dedicated response	6-5
RS-422A/485 interface specification	3-1

S

secondary	2-3, 2-10
sender	2-38
sender URL	2-39
serial interface converter	3-8
serial interface specification	3-1
setting command	5-3
setting command (control)	5-17, 5-20
setting command (setting)	5-9
setting/measurement server	1-3
signal direction	3-2
signal name (RS-232)	3-2
signal name (RS-422A/485)	3-5
single negative response	6-1
slave	4-1
SMTP server	2-38
soft key	iv
space code	App-1
special data value	6-21
special message	6-10
starting/stopping e-mail transmissions	2-48
status information	7-1
status report	7-1
storing operation	vii
sub delimiter	5-2
subnet mask	2-3

T

terminator	3-1, 3-8, 5-2
time difference from GMT	2-27
time out	1-5
timeout time	2-18, 4-7
type (Modbus register data)	4-8
types of ASCII data	6-6

U

UDP	1-1
UINT16	4-8
UINT32_B	4-9
UINT32_L	4-9

Index

URL 2-31
use of part iv
user 1-5, 2-17
user authorization 1-5
user level 2-17
user name 2-17, 2-26, 2-27
user registration 2-17

W

web operation log 2-23
web server 1-6

X

XON-RS 3-4
XON-XON 3-4